



CATALOG DE PRODUSE 2023



SOBE ȘI ȘEMINEE



ACCESORII SOBE ȘI ȘEMINEE



ROABE ȘI ACCESORII



BETONIERE ȘI ACCESORII



SCĂRI METALICE



PRODUSE DE UZ GOSPODĂRESC



UNELTE



CAZANE DE ȚUICĂ



BUTOAIE INOX



YOUR WHOLESALE PARTNER

Firma noastră este printre distribuitorii de elită din România în comercializarea accesoriilor pentru sobe și șeminee din fontă/tablă, a uneltelor de uz gospodăresc, a accesoriilor de construcții, scări metalice și a cazanelor de țuică.

Firma s-a înființat în anul 1992; în timpul activității am deschis trei depozite – două în județul Covasna, una în județul Ilfov, de asemenea am deschis magazine de prezentare în județele Covasna și Ilfov.

Produsele noastre

Ne străduim să comercializăm produse de înaltă calitate la prețuri foarte bune. Am introdus pe piață produse care nu erau încă prezente, cum ar fi cazanele de țuică, accesorii din fontă pentru sobe și ceaune.

Importăm din următoarele țări

Uniunea Europeană:

Bulgaria, Ungaria, Slovacia, Cehia, Polonia și Slovenia.

Din afara Uniunii Europene:

Serbia, Ucraina, Macedonia, Bosnia și Turcia.

Din afara Europei:

China.

SOBĂ ATELIER



Detalii		
Dimensiuni: 71×35×35 cm	1	21
Putere: 4 - 5 kW		
Diametru horn: 120 mm		

SOBĂ RACHETĂ



Detalii		
Dimensiuni: 36×33×69 cm	1	13

SOBĂ RUSTICĂ



Modele	Detalii		
Stânga	Dimensiuni: 46×40×76 cm	1	35
Dreapta	Putere: 4 - 5 kW		
	Diametru horn: 120 mm		

SOBĂ FANTAZIA ALB



Modele	Detalii		
Stânga	Dimensiuni: 80×44×75 cm	1	60
Dreapta	Putere: 6 - 9 kW		
	Diametru horn: 130 mm		

SOBĂ FANTAZIA MARO



Modele	Detalii		
Stânga	Dimensiuni: 80×44×75 cm	1	60
Dreapta	Putere: 6 - 9 kW		
	Diametru horn: 130 mm		

SOBĂ GRAND FANTAZIA



Modele	Detalii		
Stânga	Dimensiuni: 89×51×75 cm	1	70
Dreapta	Putere: 7,5 kW		
	Diametru horn: 130 mm		

SOBĂ BK 50



Modele	Detalii		
Stânga	Dimensiuni: 82×52×84 cm	1	77
Dreapta	Putere: 7 kW		
	Diametru horn: 130 mm		

SOBĂ FONTĂ BDS3



Detalii		
Dimensiuni: 85×53×73 cm	1	105
Putere: 7 - 10 kW		
Diametru horn: 120 mm		

ȘEMINEU ZORA



Detalii		
Dimensiuni: 63×48,5×88,5 cm	1	45
Putere: 8 kW		
Diametru horn: 120 mm		

ȘEMINEU SUB7



Detalii		
Dimensiuni: 91,5×37,5×37,5 cm	1	56
Putere: 7 kW		
Diametru horn: 120 mm		

PLITĂ MORANO



Dimensiuni		
38 x 38 cm	1	4,5

PLITĂ ALEX



Dimensiuni		
40 x 46 cm	1	6,4

PLITĂ METEOR, VESTA



Tip	Dimensiuni		
Meteor	47,5 x 32 cm	1	4,9
Vesta	39,5 x 32 cm	1	4,2

GARNITURĂ FANTAZIA



Dimensiuni		
80 x 44 cm	1	14,5

PLITĂ 3 OCHI

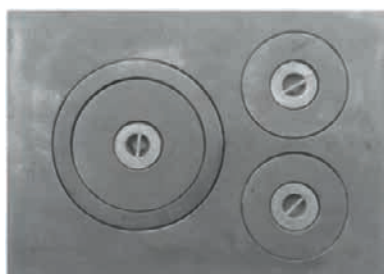

Tip	Dimensiuni		
Mic	53,5 x 38 cm	1	7,6
Mare	64 x 47,5 cm	1	13,5

PLITĂ CIZMA



Dimensiuni		
27 x 39,5 cm	1	3,1

GARNITURĂ 3 OCHI

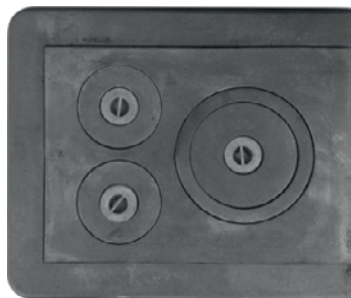

Tip	Dimensiuni		
Mic	61 x 53 cm	1	13,5
Mare	72 x 64 cm	1	18,6

SET PLITĂ METEOR

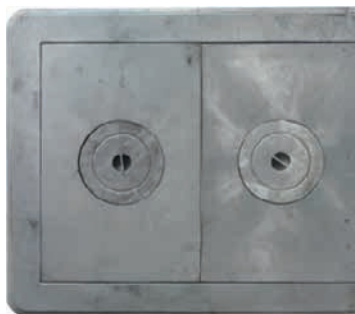

Dimensiuni		
69,5 x 60 cm	1	18,6

SET PLITĂ VESTA

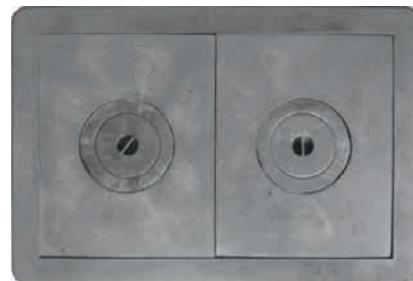

Dimensiuni		
75,5 x 49,5 cm	1	14,4

GARNITURĂ METEOR



Dimensiuni		
95 x 60 cm	1	23,5

GRĂȚAR



Variante		
16 x 20 cm	1	1,1
16,5 x 24,5 cm	1	1,4
17 x 23 cm	1	1,5
20 x 30 cm	1	2,3
25 x 40 cm	1	5



PICIOR SOBĂ



Detalii		
Fontă, 30 cm	1	0,7

UȘĂ FIREWORK





Dimensiuni  
 Exterior: 34,5 x 55 cm
 Geam: 17,5 x 15,5 x 0,4 cm

1 13

UȘĂ TRANSI





Dimensiuni  
 Exterior: 34,5 x 55 cm
 Geam: 17,5 x 15,5 x 0,4 cm

1 13

UȘĂ VITRUM





Dimensiuni  
 Exterior: 28,5 x 49 cm
 Geam: 25 x 22 x 0,4 cm

1 12

UȘĂ ȘEMINEU VISIO





Dimensiuni  
 Exterior: 46 x 48 cm
 Geam: 26 x 32 x 0,4 cm

1 14

UȘĂ ȘEMINEU PROPTER





Dimensiuni  
 Exterior: 50 x 50 cm
 Geam: 40 x 40 x 0,4 cm

1 15

UȘĂ ȘEMINEU CAMUR





Detalii  
 Dimensiuni: 50 x 35 cm
 Geam: 40 x 30 x 0,4 cm

1 14

UȘĂ DIN 2 PĂRȚI, NEGRU





Dimensiuni  
 Ușă: 25 x 27 cm
 Cenușar: 15 x 25 cm

5 8

UȘĂ DIN 2 PĂRȚI, ARGINTIU





Dimensiuni  
 Ușă: 25 x 27 cm
 Cenușar: 15 x 25 cm

5 9

UȘĂ MONOBLOC





Dimensiuni  
 28,5 x 49 cm

5 9

UȘĂ MONOBLOC CU GEAM





Dimensiuni  
 Exterior: 28,5 x 49 cm
 Geam: 15 x 13 x 0,4 cm

5 9

UȘĂ DIN 2 BUCĂȚI, CU GEAM





Dimensiuni  
 Ușă: 25 x 27 cm
 Cenușar: 15 x 25 cm
 Geam: 15 x 13 x 0,4 cm

5 6

UȘĂ CENUȘAR LORGAN



Detalii  
 Dimensiuni: 50 x 23 cm
 Montaj: 42 x 14 cm

1 13

UȘĂ EXTERIOR BARBECUE

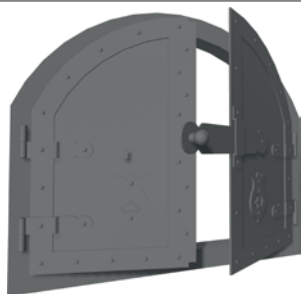

Detalii

560 × 658 mm	1	11,5
--------------	---	------

UȘĂ CUPTOR EXTERIOR ROBY

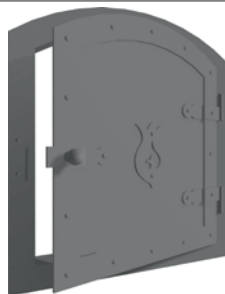

Detalii

615 × 565 mm	1	10,7
515 × 465 mm	1	8,3

UȘĂ CUPTOR EXTERIOR RUSTIC



Detalii

515 × 565 mm	1	9,8
415 × 465 mm	1	7,6

UȘĂ CENUȘAR

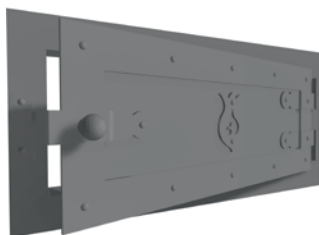

Detalii

265 × 565 mm	1	6,6
265 × 465 mm	1	5,6
310 × 360 mm	1	5,2

UȘĂ PANAMA cu GEAM



Detalii

Dimensiuni: 480 × 595 mm	1	15
Geam: 180 × 380 mm		

UȘĂ PANAMA fără GEAM



Detalii

Dimensiuni: 480 × 595 mm	1	14,5
--------------------------	---	------

UȘĂ FORJATĂ



Detalii

Dimensiuni: 355 × 525 mm	1	12
--------------------------	---	----

UȘĂ BOLTĂ CU CENUȘAR



Detalii

Dimensiuni: 320 × 490 mm	1	13,6
Geam: 180 × 230 mm		

UȘĂ BOLTĂ



Detalii

Dimensiuni: 320 × 370 mm	1	8,4
Geam: 180 × 230 mm		

ARZĂTOR GAZ DIN FONTĂ



Detalii

Dimensiuni: 41 × 13 cm	1	4
Diametru arzător: 16,5 cm		

BURLAN EMAILAT



Detalii		
Maro, Ø120 × 1000 × 0,5 mm	12	1,6
Maro, Ø120 × 500 × 0,5 mm	12	0,7
Maro, Ø120 × 250 × 0,5 mm	12	0,5
Maro, Ø110 × 1000 × 0,5 mm	12	1,5
Maro, Ø110 × 500 × 0,5 mm	12	0,7
Maro, Ø110 × 250 × 0,5 mm	12	0,4
Alb, Ø120 × 1000 × 0,5 mm	12	1,6
Alb, Ø120 × 500 × 0,5 mm	12	0,7
Alb, Ø120 × 250 × 0,5 mm	12	0,5
Alb, Ø110 × 1000 × 0,5 mm	12	1,5
Alb, Ø110 × 500 × 0,5 mm	12	0,7
Alb, Ø110 × 250 × 0,5 mm	12	0,4
Maro, Ø110 × 1000 × 0,4 mm	12	1,1
Maro, Ø120 × 1000 × 0,4 mm	12	1,2
Maro, Ø120 × 500 × 0,4 mm	12	0,6
Maro, Ø130 × 1000 × 0,4 mm	9	1,2
Maro, Ø130 × 500 × 0,4 mm	9	0,6

COT EMAILAT

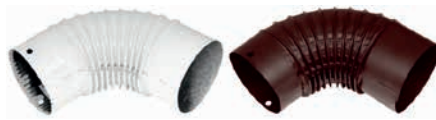

Detalii		
Maro, Ø110 × 0,5 mm	12	0,7
Maro, Ø120 × 0,5 mm	12	0,7
Maro, Ø110 × 0,4 mm	20	0,5
Maro, Ø120 × 0,4 mm	20	0,5
Maro, Ø130 × 0,5 mm	20	0,6
Alb, Ø110 × 0,5 mm	12	0,7
Alb, Ø120 × 0,5 mm	12	0,7

COT



Detalii		
Nevopsit, Ø110 × 0,5 mm	20	0,5
Nevopsit, Ø120 × 0,5 mm	20	0,5
Nevopsit, Ø150 × 0,5 mm	20	1
Vopsit, negru Ø120 × 0,5 mm	12	0,7
Vopsit, negru Ø150 × 0,5 mm	6	1,3

COCOȘ VÂNT



Detalii		
Zincată, Ø120 × 0,5 mm	1	0,6
Zincată, Ø150 × 0,5 mm	1	0,9
Emailat, negru, Ø120 × 0,5 mm	1	0,8

PĂLĂRIE FUM ZINCATĂ



Detalii		
Ø120 × 0,5 mm	10	0,3

BURLAN



Detalii		
Nevopsit, Ø110 × 1000 × 0,5 mm	12	1,2
Nevopsit, Ø120 × 1000 × 0,5 mm	12	1,3
Nevopsit, Ø150 × 1000 × 0,5 mm	6	1,5
Vopsit, Ø120 × 1000 × 0,5 mm	12	1,6
Vopsit, Ø150 × 1000 × 0,5 mm	6	2,2

ROZETĂ BURLAN



Detalii		
Emailat, alb, Ø120 × 0,5 mm	50	0,2
Emailat, maro, Ø120 × 0,5 mm	50	0,2
Vopsit, negru, Ø120 × 0,5 mm	50	0,2
Emailat, alb, Ø120 × 0,4 mm	30	0,2
Emailat, maro, Ø120 × 0,4 mm	30	0,2
Zincată, Ø120 × 0,4 mm	100	0,1
Zincată, Ø110 × 0,5 mm	10	0,1
Zincată, Ø120 × 0,5 mm	10	0,1

RECUPERATOR CĂLDURĂ



Detalii		
Emailat, alb, Ø120 × 500 × 0,5 mm	1	2,2
Emailat, maro, Ø120 × 500 × 0,5 mm	1	2,2
Emailat, maro, Ø120 × 500 × 0,4 mm	3	2,0
Vopsit, negru, Ø120 × 500 × 0,5 mm	1	2,2
Vopsit, negru, Ø120 × 1000 × 0,5 mm	1	4
Emailat, maro, Ø130 × 500 × 0,4 mm	3	2,4

REDUCȚIE BURLAN



Detalii		
Emailat, alb, Ø130 → Ø120 × 0,5 mm	100	0,2
Emailat, maro, Ø130 → Ø120 × 0,5 mm	100	0,2
Vopsit, negru, Ø130 → Ø120 × 0,5 mm	100	0,2
Nevopsit, Ø120 → Ø110 × 0,5 mm	20	0,2
Nevopsit, Ø150 → Ø120 × 0,5 mm	20	0,2

CAPSĂ PERETE



Detalii		
Zincată, Ø120 mm	1	0,1

TAVĂ CENUȘAR



Detalii		
Zincată, 230 × 450 mm	1	0,4

UȘĂ HORN DIN TABLĂ



Detalii		
Vopsită, negru, 165 × 300 mm	1	0,8
Zincată, 165 × 300 mm	10	0,8

UȘĂ HORN DIN BETON



Detalii		
24,5 × 18,5 × 5,5 cm	1	4,5

CUPTOR ȚĂRĂNESC



Detalii		
Tablă, 380 × 270 × 200 mm	1	2,6

CUPTOR FANTAZIA



Detalii		
400 × 400 × 200 mm	1	3,8

CUPTOR CU UȘĂ FONTĂ MG



Detalii		
380 × 210 × 280 mm	1	7,2

BANDĂ TERMOREZISTENTĂ



Detalii		
10 × 2 mm	100	5

ȘNUR TERMOREZISTENT



Detalii		
6 mm	100	2,8
8 mm	100	3,4
10 mm	50	2,9
12 mm	100	6,7

CAP PERIE HORN



Detalii		
Ø120 mm	1	0,2
Ø150 mm	1	0,2
Ø160 mm	1	0,2
Ø180 mm	1	0,2
Ø200 mm	1	0,3
Ø250 mm	1	0,3

CABLU PENTRU PERIE HORN



Detalii		
3 m	1	0,8
5 m	1	1,3

ROABĂ WB6414PL



Detalii		
Volum cuvă: 85 l	50	18
Cuvă: plastic		
Dimensiuni: 138 x 62 x 54 cm		
Roată cu cam. 400 x 100 mm, ax: 20 mm		

ROABĂ SK ZINCATĂ



Detalii		
Volum cuvă: 85 l	1	18
Cuvă: Zincată		
Dimensiuni: 165 x 60 x 90 mm		
Roată plină 65 x 40 x 14 mm		

ROABĂ DETEX PROFESIONALĂ 85L



Detalii		
Volum cuvă: 85 l, (150 kg)	60	11
Cuvă: Zincată, 0,7 mm		
Dimensiuni: 89 x 60 x 90 cm		
Roată cu cam. 350 x 80 mm, ax: 14 mm		

ROABĂ BASCULABILĂ



Detalii		
Dimensiuni: 92/50 x 50 x 108 cm	1	10
Cuvă: plastic; volum: 75 l, (120 kg); Roată cu cameră 10" x 3,50-4		

ROABĂ DETEX PROFESIONALĂ 100L



Detalii		
Volum cuvă: 100 l, (14 kg)	5	12
Cuvă: Zincată, 0,7 mm		
Dimensiuni: 140 x 61 x 55 cm		
Roată cu cameră, 40 x 9 cm, ax: 15 mm		

CUVĂ ZINCATĂ



Detalii		
0,7 mm, 92 l	1	4
0,6 mm, 85 l	1	3,5

Cărucior de marfă



Detalii		
Dimensiuni: 68 x 60 x 120 cm	1	18
Roată plină, 25 x 5,5 cm, ax: 20 mm		

ROABĂ TR 75 L



Detalii		
Volum cuvă: 75 l, (11 kg)	1	10,8
Cuvă: Zincată, 0,7 mm		
Dimensiuni: 78 x 140 x 48 cm		
Roată plină, 33,5 x 7,5 cm, ax: 20 mm		

CUVĂ PLASTIC



Detalii		
0,7 mm, 85 l	1	3,1

ROATĂ LIMEX CU CAMERĂ



Detalii		
350 x 80 mm, ax: 14 mm	1	2,5

ROATĂ CHINA CU CAMERĂ



Detalii		
400 x 100 mm, ax: 20 mm	1	2

ROATĂ PLINĂ



Detalii		
65 x 40 cm, ax: 14 mm	1	6

ROATĂ PLINĂ TR



Detalii		
33,5 x 7,5 cm, ax: 20 mm	1	3,2

ROATĂ CU SPUMĂ



Detalii		
35 x 8 cm, ax: 15 mm	1	1,5

BETONIERĂ 130L



Detalii

Volum cuvă: 130 l
Volum material: 80 l
Consum: 800 W
Termen de garanție: 24 luni

 
1 52

BETONIERĂ 155L



Detalii

Volum cuvă: 155 l
Volum material: 110 l
Consum: 1000 W
Termen de garanție: 24 luni

 
1 58

BETONIERĂ 320L



Detalii

Volum cuvă: 320 l
Volum material: 250 l
Consum: 1500 W
Termen de garanție: 24 luni

 
1 240

BETONIERĂ 190L



Detalii

Volum cuvă: 190 l
Volum material: 130 l
Consum: 1000 W
Termen de garanție: 24 luni

 
1 67

CUREA DE TRANSMISIE



Detalii

800 W

 
1 0,2

MOTOR ELECTRIC



Tip

800 W
1000 W

 
1 4
1 4,5

PINION



Tip

12 dinți
13 dinți

 
1 0,5
1 0,6

ALUMINIU, 1 TRONSON

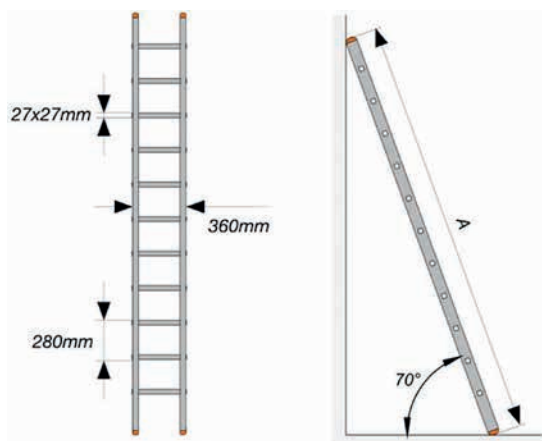

Trepte	A			
10	2,79 m	1	3,7	
12	3,35 m	1	4,5	
14	3,91 m	1	5,4	

ALUMINIU, 2 TRONSOANE

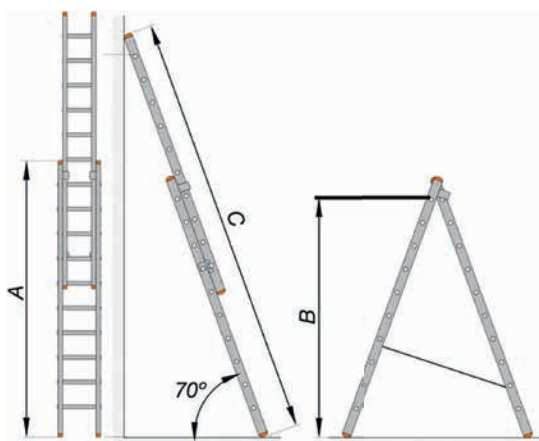

Trepte	A	B	C		
2 x 7	1,96 m	1,74 m	3,08 m	1	6,7
2 x 8	2,26 m	2,01 m	3,39 m	1	7,8
2 x 9	2,52 m	2,23 m	3,93 m	1	8,1
2 x 10	2,80 m	2,51 m	4,48 m	1	9,9
2 x 11	3,08 m	2,78 m	5,05 m	1	11,6

ALUMINIU, 3 TRONSOANE

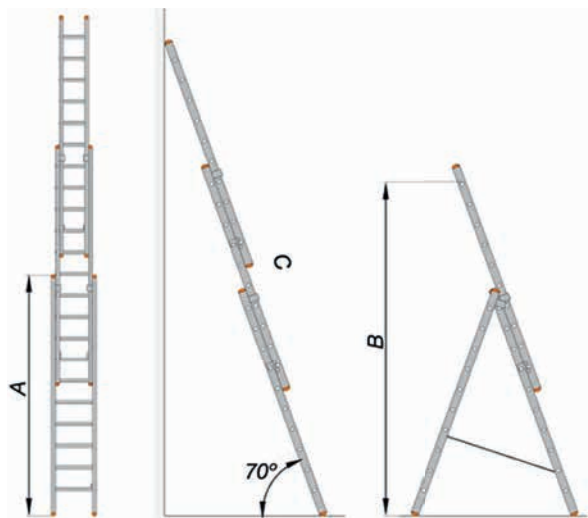

Trepte	A	B	C		
3 x 7	1,96 m	2,81 m	4,21 m	1	9,5
3 x 8	2,26 m	3,08 m	4,51 m	1	11,0
3 x 9	2,52 m	3,76 m	5,33 m	1	11,9
3 x 10	2,79 m	4,19 m	6,16 m	1	15,2
3 x 11	3,08 m	4,74 m	7,01 m	1	17,1

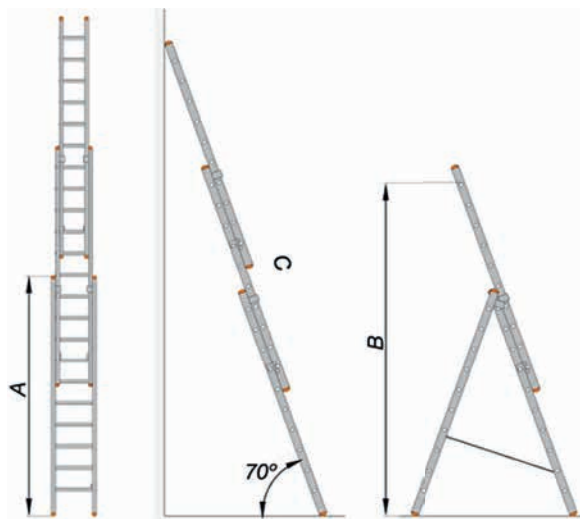

ALUMINIU, 3 TRONSOANE, PROFESIONAL



Trepte	A	B	C		
3 x 12	3,43 m	5,35 m	7,43 m	1	26
3 x 13	3,73 m	5,90 m	8,23 m	1	28
3 x 14	4,00 m	6,46 m	9,01 m	1	30
3 x 15	4,28 m	7,00 m	9,80 m	1	32



METALIC 2+1



Trepte	înălțime		
2 + 1	1,15 m	1	4,5
3 + 1	1,41 m	1	5,3
4 + 1	1,63 m	1	6,3
5 + 1	1,90 m	1	7,4
6 + 1	2,10 m	1	8,5
7 + 1	2,36 m	1	9,7
8 + 1	2,61 m	1	11,4
9 + 1	2,81 m	1	12

METALIC 2+2



Trepte	înălțime		
3 + 3	1,20 m	1	5,5
4 + 4	4,40 m	1	6,5
5 + 5	1,70 m	1	8,5
6 + 6	1,90 m	1	9,5
7 + 7	2,10 m	1	11,5
8 + 8	2,40 m	1	13
9 + 9	2,60 m	1	11,4

SCARĂ TIP SCHELĂ



Detalii
 Trepte: 6 + 6
 Material: aluminiu
 Dimensiuni: 159 x 70 x 165 cm

 
 1 17

SCHELĂ



Detalii
 Trepte: 3 + 6 + 3
 Material: aluminiu
 Dimensiuni: 150 x 70 x 97 cm

 
 1 10

PLASĂ SUDATĂ

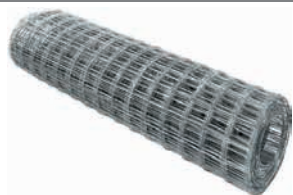

Detalii		
1,20 x 20 m	20 m	11
1,50 x 20 m	20 m	13
1,70 x 20 m	20 m	15
2,00 x 20 m	20 m	18

PLASĂ ÎMPLETITĂ

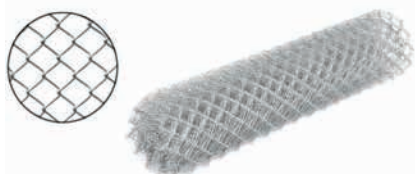

Detalii		
1,2 x 10 m	10 m	13
1,2 x 20 m	20 m	25
1,5 x 10 m	10 m	15
1,5 x 20 m	20 m	30
1,7 x 10 m	10 m	18
1,7 x 20 m	20 m	35
2 x 20 m	20 m	40

PLASĂ RABIȚ



Detalii		
1 x 25 m	25 m	10

SĂRMĂ GHIMPATĂ



Detalii		
Zincată, 2 mm	100 m	10

SĂRMĂ



Detalii		
Neagră, 0,8 mm	1	1
Neagră, 1,2 mm	1	1
Neagră, 2 mm	1	1
Neagră, 3 mm	1	1
Neagră, 4 mm	1	1
Zincată, 0,8 mm	1	1
Zincată, 1,2 mm	1	1
Zincată, 3 mm	1	1
Tare mată, 3 mm	5	5

CUIE CONSTRUCȚII



Detalii		
1,40 x 25 mm	5	5
1,80 x 30 mm	5	5
1,80 x 40 mm	5	5
2,00 x 40 mm	5	5
2,25 x 50 mm	5	5
2,50 x 50 mm	5	5
2,25 x 60 mm	5	5
2,50 x 60 mm	5	5
2,80 x 60 mm	5	5
3,00 x 60 mm	5	5
3,00 x 70 mm	5	5
3,00 x 80 mm	5	5
3,50 x 90 mm	5	5
4,00 x 100 mm	5	5
4,00 x 120 mm	5	5
5,00 x 150 mm	5	5
6,00 x 180 mm	5	5
7,00 x 200 mm	5	5
7,00 x 220 mm	5	5
7,60 x 230 mm	5	5
7,60 x 250 mm	10	10

CUIE



Detalii		
Tablă 3,00 x 30 mm	5	5
Tapițerie 1,60 x 18 mm	5	5
Tapițerie 2,00 x 20 mm	5	5
Scoabe 2,50 x 25 mm	5	5

CAIELE



Detalii		
Caiete E6 54,0	250	1
Caiete E7 57,0	250	1,1
Caiete E8 60,5	250	1,3
Caiete E9 64,0	250	1,5

SCOABE



Detalii		
8 x 250 mm	50	0,1
10 x 250 mm	25	0,2

ELECTROZI



Detalii		
Supertit Fin 2,50 mm	1	4,5
Supertit Fin 3,25 mm	1	5,8
Supertit Fin 4,00 mm	1	5,5
Bazici 2,50 mm	1	4
Bazici 3,25 mm	1	5,5
Bazici 4,00 mm	1	5

SUPORT GRINDĂ



Detalii		
Cu talpă 80 mm	1	0,7
Cu talpă 100 mm	1	0,8
Cu talpă 120 mm	1	1,1
Cu talpă 150 mm	1	1,3
Simplă 80 mm	1	0,7
Simplă 100 mm	1	0,8
Simplă 120 mm	1	1
Simplă 150 mm	1	1,1

LANȚ INDUSTRIAL



Detalii		
3 mm	117,5 m	25
4 mm	77,5 m	25
5 mm	52,5 m	25
6 mm	35,3 m	25
7 mm	26 m	25
8 mm	20,5 m	25
10 mm	13 m	25

LANȚ CÂINE, VITĂ



Detalii		
Pentru câine, 4 mm x 3 m	50	0,9
Pentru vită, 5 mm, 75 x 100 cm	60	0,8
Pentru vită, 6 mm, 100 x 100 cm	40	1,2
Pentru vită, 7 mm, 100 x 100 cm	25	1,7

CAPAC CANALIZARE



Detalii		
Vopsit 50 x 50 cm	1	10
Vopsit 60 x 60 cm	1	12
Vopsit 75 x 75 cm	1	15
Vopsit 100 x 100 cm	1	20
Galvanizat 50 x 50 cm	1	10
Galvanizat 60 x 60 cm	1	12
Galvanizat 75 x 75 cm	1	15

CIUBĂR MORTAR



Detalii		
Pătrat 71 x 40 x 20, 40 l	1	1
Pătrat 71 x 40 x 29, 60 l	1	1,5
Vopsit 71 x 54 x 29, 80 l	1	2
Rotund 60 x 38, 90 l	1	2,2

GĂLEATĂ PLASTIC



Detalii		
Rotund 31 x 26, 12 l	1	1
Rotund 33 x 24, 16 l	1	1,5
Rotund 39 x 29, 20 l	1	2

GĂLEATĂ ZINCATĂ



Detalii		
10 l, 0,39 mm	1	1
12 l, 0,39 mm	1	1,5
15 l, 0,39 mm	1	2
12 l, 0,50 mm	1	1,8

CEAUN EMAILAT



Capacitate			Capacitate		
6 l	1	0,7	25 l	1	4
8 l	1	1,5	30 l	1	4,5
10 l	1	2	50 l	1	7
13 l	1	2,5	70 l	1	9
16 l	1	3	100 l	1	15
20 l	1	3,5			

SUPORT CEAUN



Detalii		
100 cm	1	1
120 cm	1	1,5

GRĂȚAR DIN FONTĂ



Detalii		
Dimensiuni: 40 x 55 x 85 cm	1	37
Grătar: 48 x 35 cm		

GRĂȚAR PICNIC



Detalii		
Dimensiuni: 55 x 55 x 58 cm	1	25
Grătar: 48 x 35 cm		



SOBĂ DE FIERT



Detalii		
Diametru: 31 cm	1	5
Diametru: 36 cm	1	5,5
Diametru: 39 cm	1	5,8
Diametru: 42 cm	1	6,1
Diametru: 53 cm	1	6,6

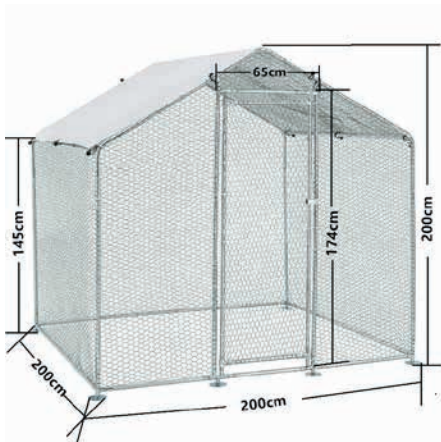

COTEȚ PENTRU GĂINI, 2 x 2 m



Detalii  
Dimensiuni: 2 x 2 x 2 m 1 24

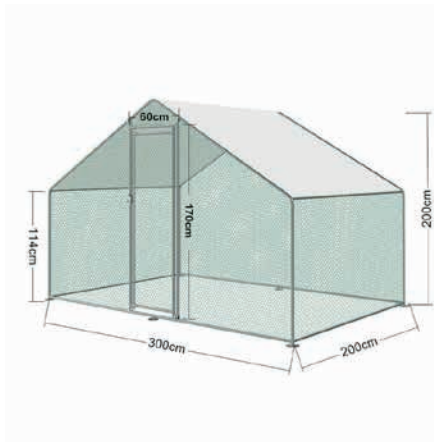

COTEȚ PENTRU GĂINI, 3 x 2 m



Detalii  
Dimensiuni: 3 x 2 x 2 m 1 29

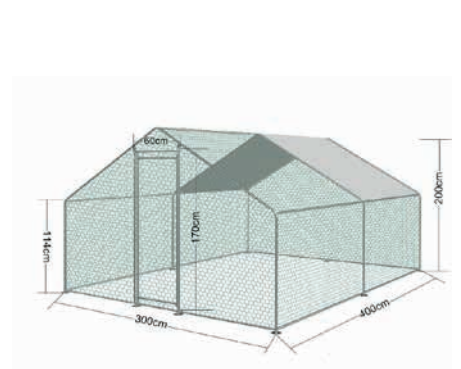

COTEȚ PENTRU GĂINI, 3 x 4 m



Detalii  
Dimensiuni: 3 x 4 x 2 m 1 37

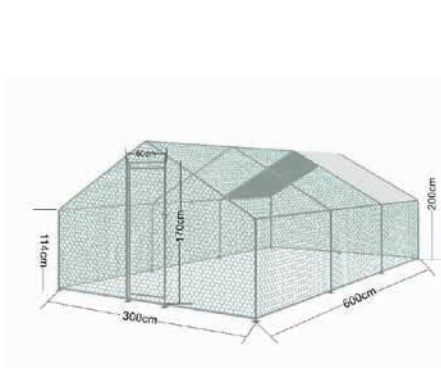

COTEȚ PENTRU GĂINI, 3 x 6 m



Detalii  
Dimensiuni: 3 x 2 x 6 m 1 48



PADOC PENTRU CÂINI, 1,5 x 3 m



Detalii  
Dimensiuni: 1,5 x 3 x 1,8 m 1 51

PADOC PENTRU CÂINI, 1,2 x 2,4 m



Detalii  
Dimensiuni: 1,2 x 2,4 x 1,5 m 1 51



POTCOAVĂ



Detalii		
0	40	0,4
1	40	0,4
2	30	0,5
3	30	0,5
2 x 0	50	0,4
3 x 0	50	0,3

CUTIE POȘTĂ



Detalii  
Tablă zincată 1 1

CAPCANĂ



Detalii  
Capcană șoareci 1 1
Capcană șobolani 1 2

CAZMA



Detalii		
Tablă	12	0,9
Fontă	12	1,3

LOPATĂ



Detalii		
Grajd	12	0,9

LOPATĂ FRANKFURT



Detalii		
Dimensiuni: 22,5x34 cm	12	1

LOPATĂ ALUMINIU



Detalii		
Mică, 26 x 29 cm	10	1
Zăpadă, 49 x 37 cm	10	1

LOPATĂ ZĂPADĂ



Detalii		
Tablă	6	1,5
Plastic	10	0,9

SAPĂ FORJATĂ



Detalii		
0,775 kg	24	0,8
0,8 kg	24	0,8
Forestier, 1,06 kg	12	1,1

SĂPĂLIGĂ



Detalii		
Forjată, 0,46 kg	50	0,5
Tablă	50	0,2

GREBLĂ FIER



Detalii		
Tablă, 12 dinți	24	0,5
Forjată, 14 dinți	24	0,8

GREBLĂ PLASTIC



Detalii		
Pentru frunze, 22 dinți	20	0,3
Mare	20	0,9

FURCĂ



Detalii		
3 brațe 345 x 200 cm	24	0,6
4 brațe 200 x 345 mm	24	0,6

FURCĂ



Detalii		
3 brațe, pentru fân, 260 x 430 mm	24	0,6
8 brațe, pentru cartofi, 270 x 370 mm	24	2

GREBLĂ PENTRU FRUNZE



Detalii		
Dimensiuni: 59x116 cm	50	1

CIOCAN FORJAT



Detalii		
3 kg	1	3,3
4 kg	1	4,3
5 kg	1	5,9
6 kg	1	6,6
8 kg	1	8,6
10 kg	1	10,6

TOPOR VERDE



Detalii		
0,6 kg	6	0,9
0,8 kg	6	1
1,2 kg	6	1,7
1,5 kg	6	2,2
2 kg	6	2,7

TOPOR FORJAT



Detalii		
0,7 kg	5	0,9
1 kg	5	1,4
1,2 kg	5	1,6
1,5 kg	5	2,1
2 kg	5	2,7
2,5 kg	5	3
2,5 kg despiciat	5	3,4

COASĂ



Detalii		
60 cm, 70 cm	10	0,5
80 cm	10	0,5

TĂRNĂCOP



Detalii		
2 kg	6	2
2,5 kg	6	2,5

COZI PENTRU UNELTE



Detalii		
Coasă	10	1,1
Furcă	10	0,8
Lopată	10	1
Sapă	10	1
Tărnăcop	10	1
Topor	10	0,8
Topor 40 cm	10	0,4
Greblă	10	1,1
Lopată zăpadă	10	1

DISC ABRAZIV



Dimensiuni		
115 x 1,2 mm	25	0,1
125 x 1,2 mm	25	0,1
150 x 1,2 mm	25	0,1
180 x 1,6 mm	25	0,1
230 x 2 mm	25	0,2

ȚESALĂ



Detalii		
Pentru cabaline	1	0,2

ULEI LANȚ



Detalii		
Ulei ungere lanț, 1 l	30	0,87

RĂZĂTOR SFECLĂ



Detalii		
35 x 40 x 80 cm	1	6,8

RAFT GALVANIZAT



Detalii		
180 x 90 x 40 cm, 175 kg/poliță	1	13

ULEI AMESTEC 2T



Detalii		
Ulei motor amestec roșu, 0,5 l	40	0,45
Ulei motor amestec roșu, 0,5 l	40	0,45

35 litri



Tip	Detalii		
Încălzire cu lemn	Dim. cazan: 70 x 50 cm, 35 l Dim. răcitor: 63 x 42 cm, 60 l Țeavă de legătură: 70 cm Cazan: cupru 1,2 - 1,5 mm Focar: tablă neagră 1,5 mm Răcitor: tablă galvanizată 0,55 mm Spiral și țeavă: cupru Ø22 x 1	1	26
Încălzire cu gaz	Dim. cazan: 63 x 46 cm, 25 l Dim. răcitor: 63 x 42 cm, 60 l Țeavă de legătură: 70 cm Cazan: cupru 1,2 - 1,5 mm Focar: tablă neagră 1,5 mm Răcitor: tablă galvanizată 0,55 mm Spiral și țeavă: cupru Ø22 x 1	1	24

80 litri



Tip	Detalii		
Tip basculant	Dim. cazan: 140 x 78 cm, 80 l Dim. răcitor: 140 x 73 cm, 320 l Țeavă de legătură: 120 cm Cazan: cupru 1,5 - 1,8 mm Focar: tablă neagră 1,5 mm Răcitor: tablă galvanizată 0,55 mm Spiral și țeavă: cupru Ø28 x 1	1	74
Tip practic	Evacuarea se face cu ajutorul vanei care are și robinet de golire montat.	1	76

60 litri



Tip	Detalii		
Tip basculant	Dim. cazan: 120 x 65 cm, 60 l Dim. răcitor: 140 x 73 cm, 320 l Țeavă de legătură: 120 cm Cazan: cupru 1,5 - 1,8 mm Focar: tablă neagră 1,5 mm Răcitor: tablă galvanizată 0,55 mm Spiral și țeavă: cupru Ø28 x 1	1	67
Tip practic	Evacuarea se face cu ajutorul vanei care are și robinet de golire montat.	1	69

100 litri



Tip	Detalii		
Tip basculant	Dim. cazan: 140 x 78 cm, 100 l Dim. răcitor: 140 x 73 cm, 320 l Țeavă de legătură: 120 cm Cazan: cupru 1,8 - 2 mm Focar: tablă neagră 1,5 mm Răcitor: tablă galvanizată 0,55 mm Spiral și țeavă: cupru Ø28 x 1	1	78
Tip practic	Evacuarea se face cu ajutorul vanei care are și robinet de golire montat.	1	80

120 litri



Tip	Detalii		
Tip practic	Dim. cazan: 145 x 83 cm, 120 l Dim. răcitor: 145 x 63 cm, 320 l Țeavă de legătură: 200 cm Cazan: cupru 1,2 - 2,5 mm Focar: tablă neagră 1,5 mm Răcitor: tablă galvanizată 0,55 mm Spiral și țeavă: cupru Ø40 x 1	1	107

160 litri



Tip	Detalii		
Tip practic	Dim. cazan: 166 x 95 cm, 160 l Dim. răcitor: 166 x 85 cm, 450 l Țeavă de legătură: 200 cm Cazan: cupru 1,8 - 2,5 mm Focar: tablă neagră 1,5 mm Răcitor: tablă galvanizată 0,55 mm Spiral și țeavă: cupru Ø40 x 1	1	133

200 litri



Tip	Detalii		
Tip practic	Dim. cazan: 175 x 95 cm, 200 l Dim. răcitor: 166 x 85 cm, 450 l Țeavă de legătură: 200 cm Cazan: cupru 1,8 - 2,5 mm Focar: tablă neagră 1,5 mm Răcitor: tablă galvanizată 0,55 mm Spiral și țeavă: cupru Ø40 x 1	1	150

350 litri



Tip	Detalii		
Tip practic	Dim. cazan: 220 x 120 cm, 350 l Dim. răcitor: 200 x 95 cm, 650 l Țeavă de legătură: 250 cm Cazan: cupru 2 - 5 mm Focar: tablă neagră 2 mm Răcitor: tablă galvanizată 1 mm Spiral și țeavă: cupru Ø50 x 1	1	353

RACHIU 6 litri



Detalii  
 Diametru: 250 mm
 Înălțime: 230 mm
 Lungime: 250 mm
 Suport încorporat

RACHIU 25 litri



Detalii  
 Diametru: 300 mm
 Înălțime: 350 mm
 Lungime: 360 mm
 Suport din lemn

RACHIU 35 litri



Detalii  
 Diametru: 300 mm
 Înălțime: 350 mm
 Lungime: 510 mm
 Suport din lemn

RACHIU 45 litri



Detalii  
 Diametru: 300 mm
 Înălțime: 350 mm
 Lungime: 600 mm
 Suport din lemn

VIN 60 litri



Detalii  
 Diametru: 400 mm
 Înălțime: 780 mm

VIN 100 litri



Detalii  
 Diametru: 400 mm
 Înălțime: 1100 mm

VIN 145 litri



Detalii  
 Diametru: 480 mm
 Înălțime: 1100 mm

VIN 180 litri



Detalii  
 Diametru: 480 mm
 Înălțime: 1300 mm

MIERE 60 litri



Detalii  
 Diametru: 400 mm
 Înălțime: 780 mm

MIERE 75 litri



Detalii  
 Diametru: 400 mm
 Înălțime: 900 mm

MURĂTURĂ 35 litri



Detalii  
 Diametru: 300 mm
 Înălțime: 350 mm



MURĂTURĂ 60 litri



Detalii  
 Diametru: 300 mm
 Înălțime: 350 mm



Bidon inox Minox, 10 litri



Detalii  
 Diametru: 32 cm 1 2,1
 Înălțime: 22 cm



Bidon inox Minox, 15 litri



Detalii  
 Diametru: 32 cm 1 2,5
 Înălțime: 28 cm

Robinet inox 1/2"



Detalii  
 Material: inox 1 2,5
 Diametru racord: 1/2"

PRESĂ STRUGURI



Detalii		
32 l, Ø35, 44 x 44 x 78 cm	1	16

ZDROBITOR STRUGURI



Variante		
Metalic, cu cil. din plastic, 22 l	1	8,5
Metalic, cu cil. din aluminiu, 22 l	1	8,5
Inox, cu cil. din plastic, 22 l	1	8,5

ZDROBITOR FRUCTE



Detalii		
Mere, 20 l	1	8,5
Fructe, 20 l	1	8,5

DROJDIE CLASSIC 8



Detalii		
Drojdie Still Spirits, 180 g	1	0,18

Drojdie VinartisFerm Top Ferm



Detalii		
Drojdie „Sacharomyces Byanus”, 100 g	1	0,1

DROJDIE UNIVERSALĂ UVAFERM



Detalii		
228, 20 g	1	0,02
CM, 20 g	1	0,02
Danstil A, 20 g	1	0,02

AROME VINARTIS



Detalii		
Caise, 200 g	1	0,2
Cireșe, 200 g	1	0,2
Gutui, 200 g	1	0,2
Mere, 200 g	1	0,2
Pere, 200 g	1	0,2
Prune, 200 g	1	0,2
Prune uscate, 200 g	1	0,2
Riesling, 200 g	1	0,2
Vișine, 200 g	1	0,2

ANTISPUMANT FOAMSOL



Detalii		
Antispumant de silicon pe bază de apă, pentru borhoturi de fructe, cereale și vin. 100 ml.	1	0,11

ENZIMĂ VINARTISZYM FLASH



Detalii		
Enzimă pectolică, 100 g.	1	0,15

ALCOOLMETRU



Detalii		
Alcoolmetru	1	0,1
Alcoolmetru cu termometru	1	0,1

SET 6 PAHARE GRAPPA



Detalii		
Volum: 40-80 ml	1	0,73

MISTRIE CU PAHARE



Detalii		
Cu 6 pahare de pălincă	1	0,5



Sediul nostru este situat în inima României,
ne putem deplasa cu ușurință în toate direcțiile.

Suntem prompti și de încredere. Puneți-ne la încercare!

Harta de distribuție





CATALOG DE PRODUSE

METAL GROUP SRL

Sediu Social

Sfântu Gheorghe, jud. Covasna
Str. Constructorilor, nr. 7.
004 0723 180 080, 004 0735 546 992
metalgroup1994@gmail.com

Depozit central/magazin

Sfântu Gheorghe, jud. Covasna
Str. Lunca Oltului, nr. 49.
004 0728 250 956
toth@metalgroup94.ro

Punct de lucru

Afumați, jud. Ilfov
DN2 km12,5, șos. București–Urziceni, nr. 16.
Pavilion Z, stand 74Z, Doraly
004 0735 169 828

www.metalgroup.ro
www.distilam.ro
www.betoniera-roaba.ro