

Instruction Manual

Dog Kennel With Roof

1.2x2.4x1.5M

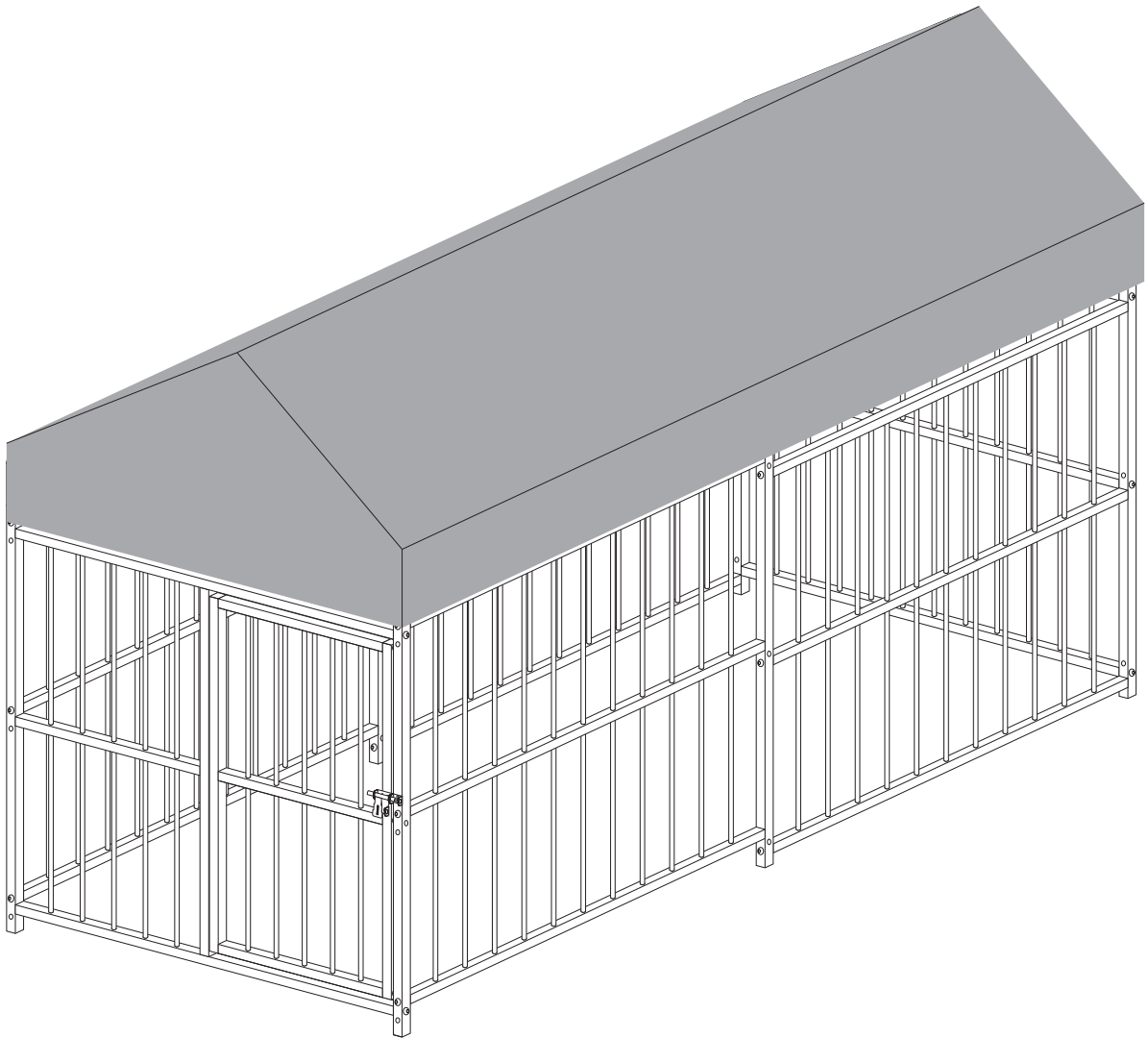

Tools:

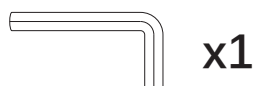

x1

Part List



1 x5pcs 1200mm



2 x10pcs 1145mm



3 x2pcs 1145mm



4 x5pcs 1145mm



5 x1pcs 1040mm



6 x1pcs 550mm



7 x1pcs 880mm

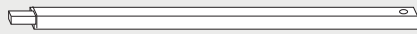

8 x2pcs 800mm pipe



D1 x1pcs 1015mm



D2 x1pcs 1015mm

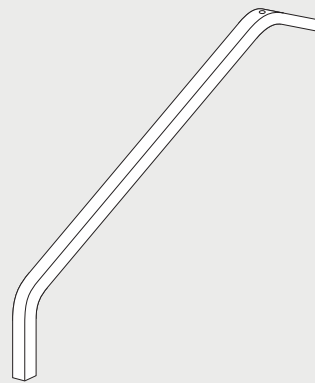

9 x3pcs

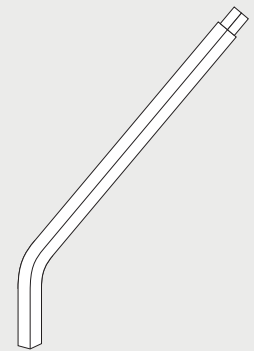

10 x3pcs



D3 x2pcs 480mm



D4 x1pcs 480mm



A x60pcs 1090mm



D5 x1pcs 1200mm



B x5pcs 1014mm

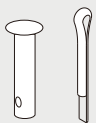

C x2pcs

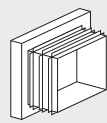

D x4pcs

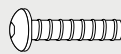

E x50pcs



x3pcs



F x1pcs Roof Cover



G x12pcs

Step 1

Install the base and column.

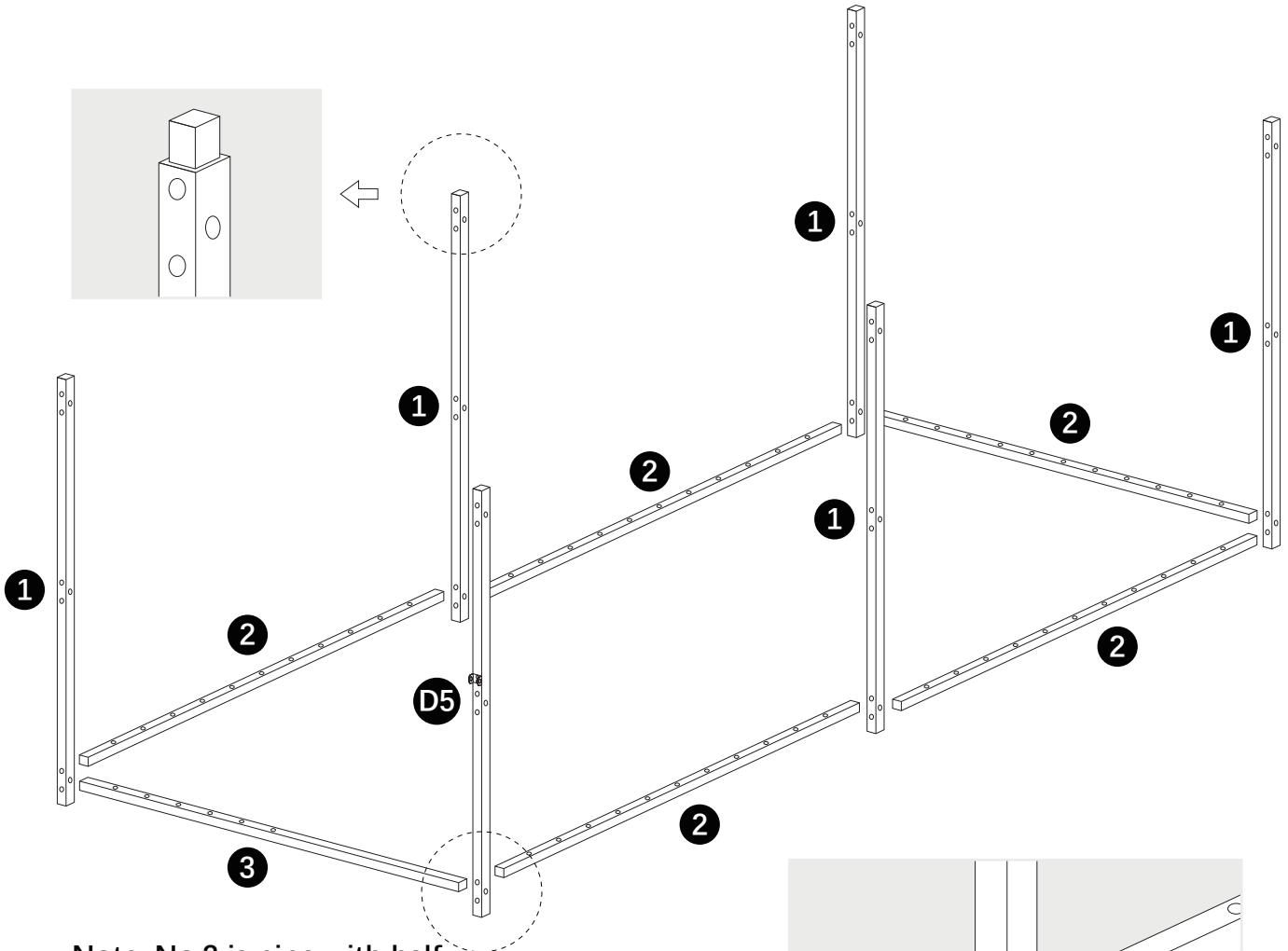

Note: No.3 is pipe with half pre-drilled holes

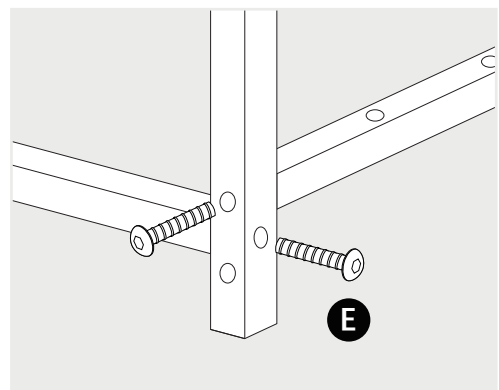

Step 2

Install the middle cross bars.

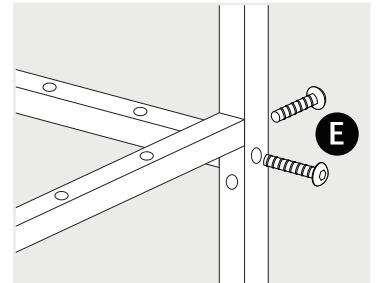
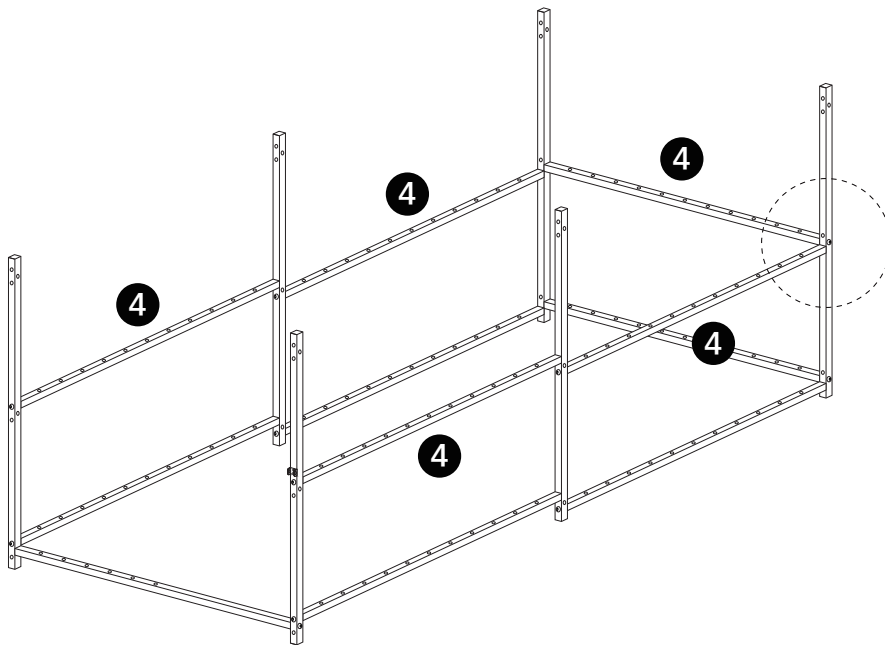

Step 3

Install facade pipes.

Install the pipe No.5, and fasten the pipe with screw "E"

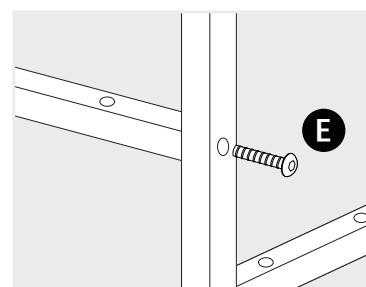
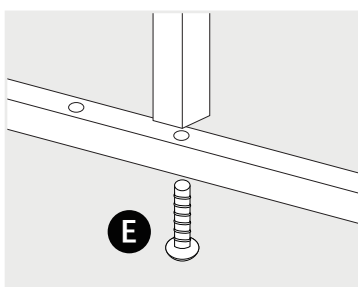
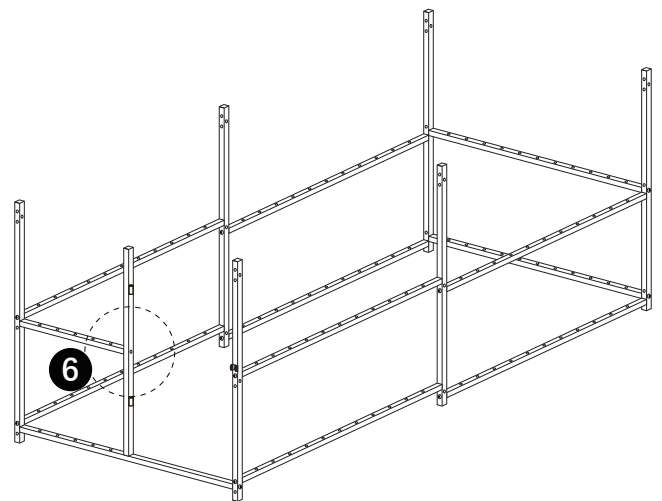
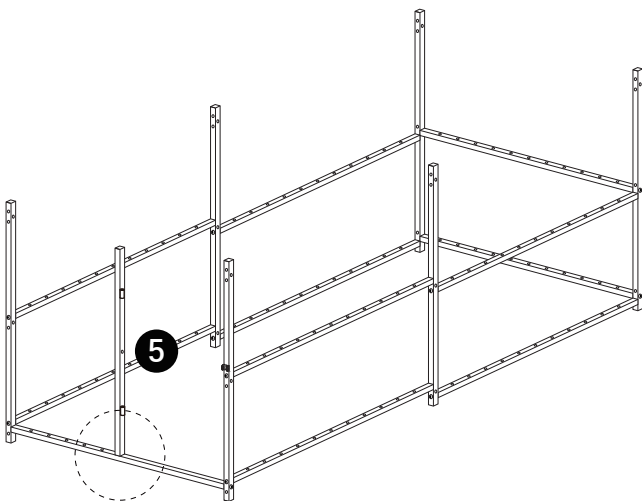

Step 4

Insert a circular tube as a grid.

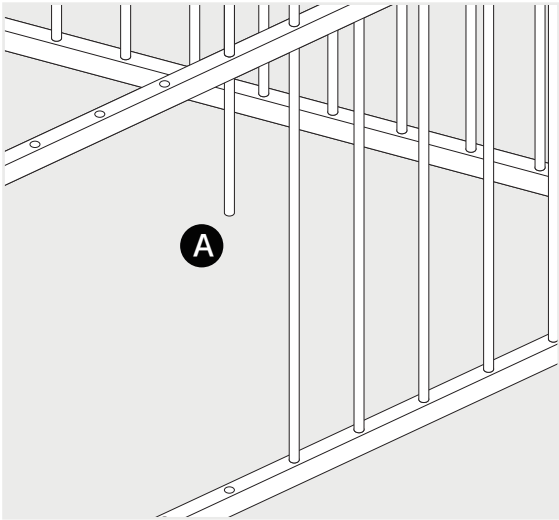
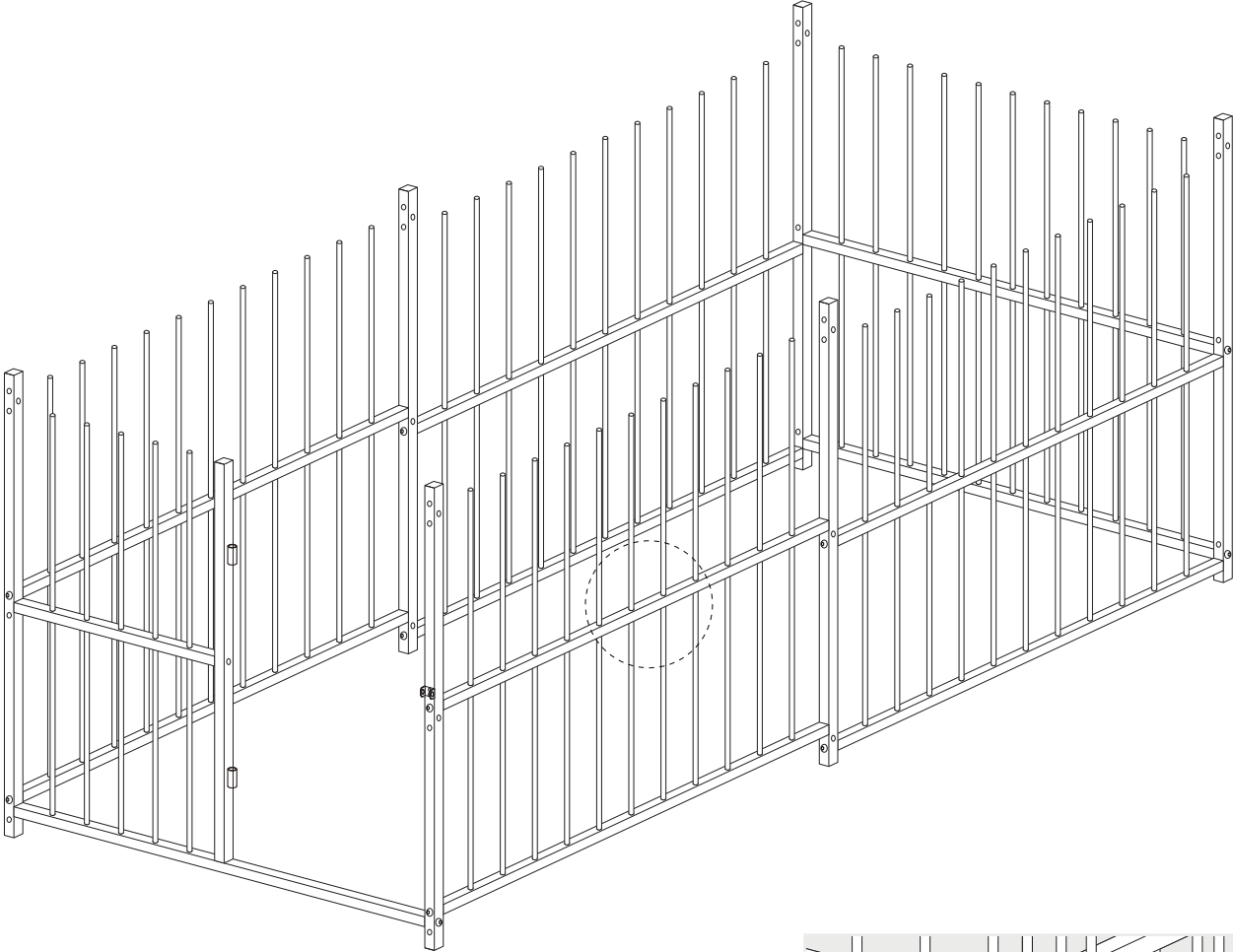

Step 5

Door fixing.

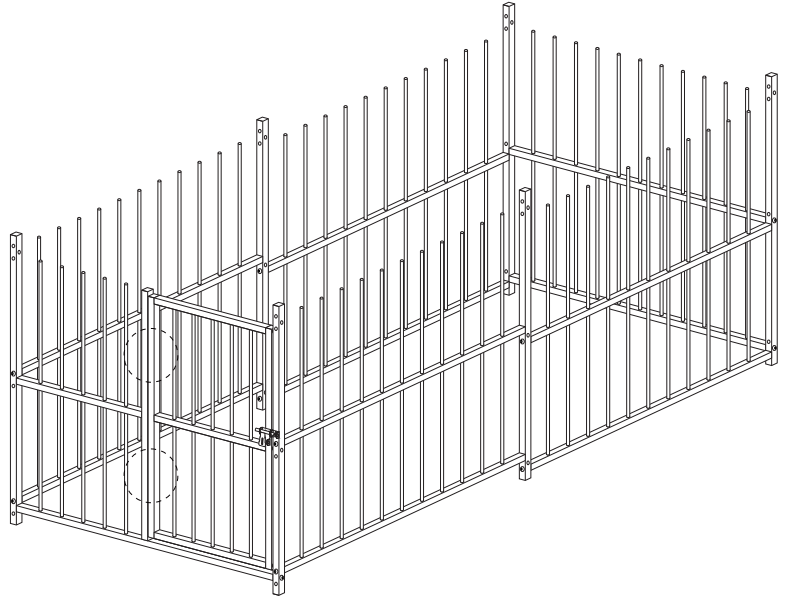
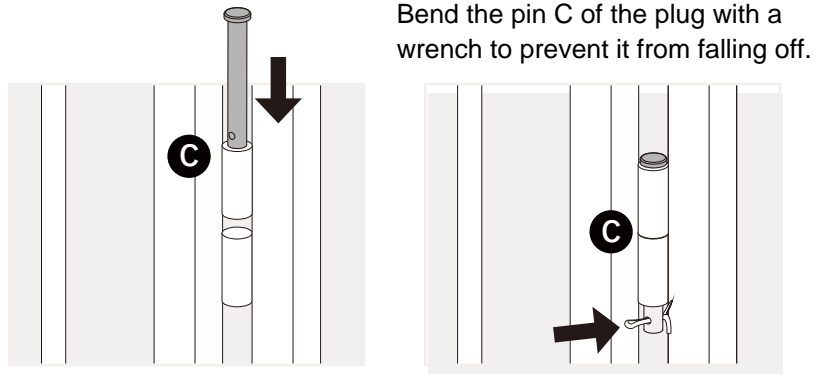
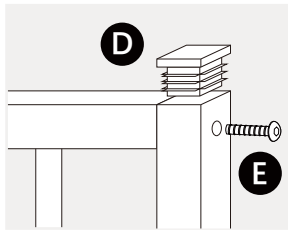
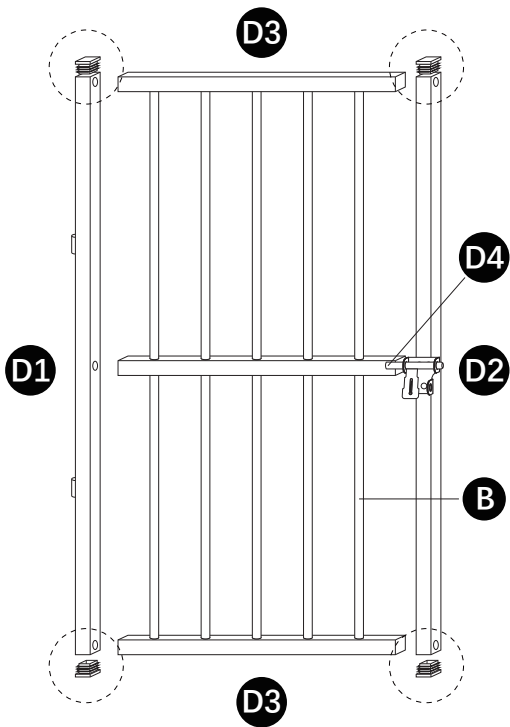

Full door view

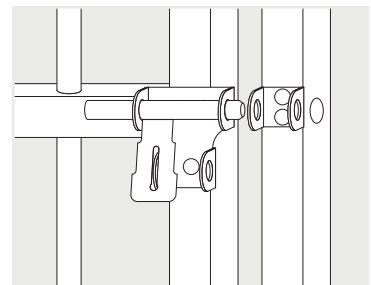
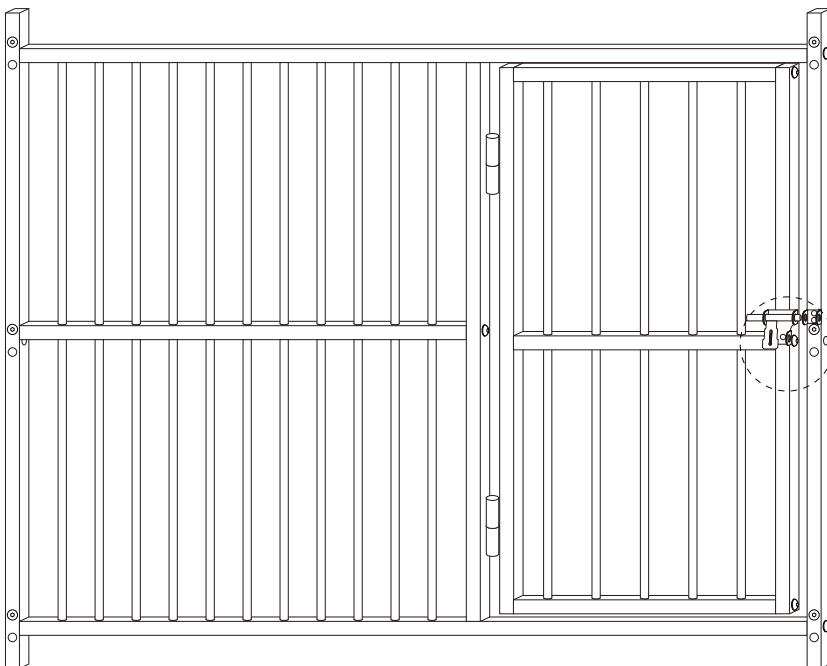

Step 6

Install the top beam pipe.

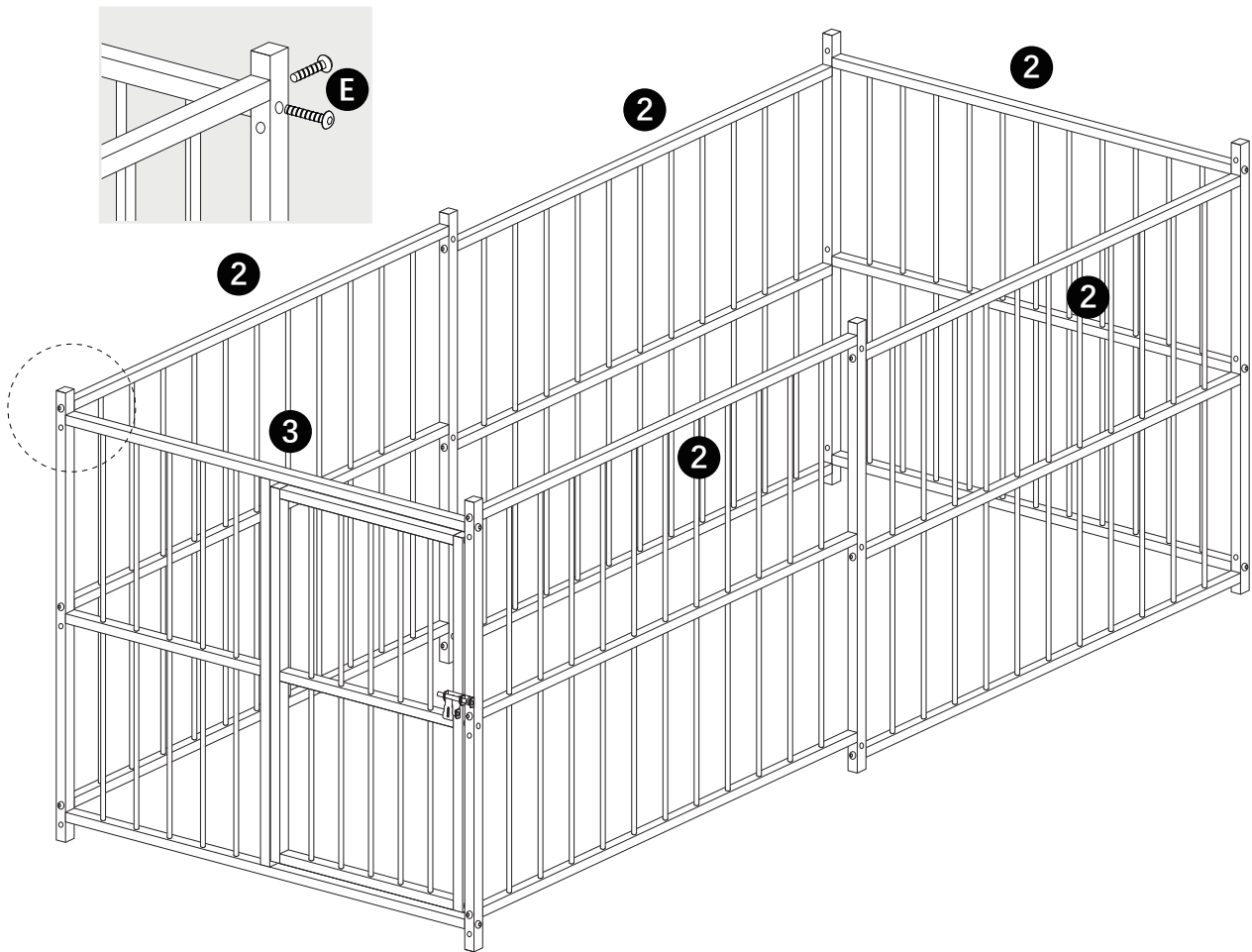

Step 7

Roof fixing.

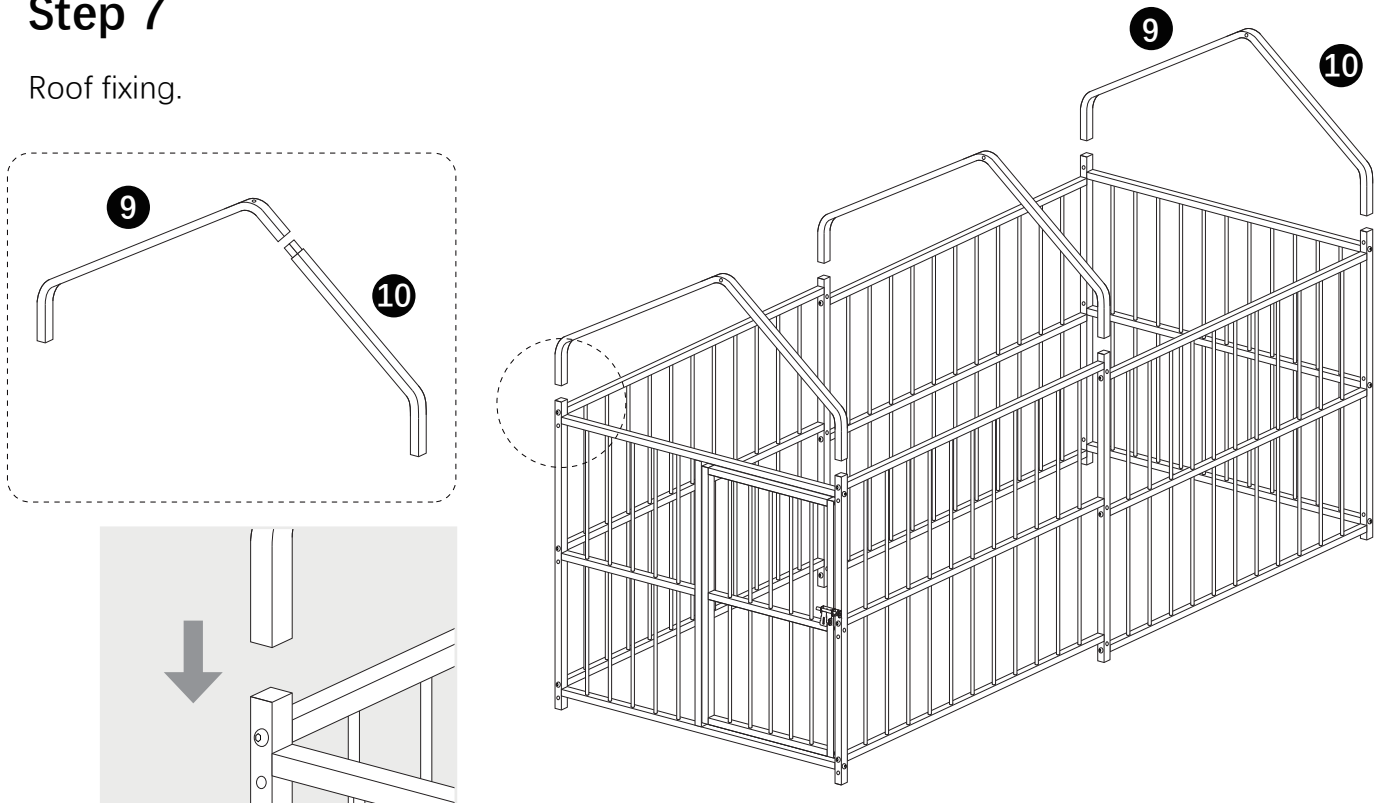

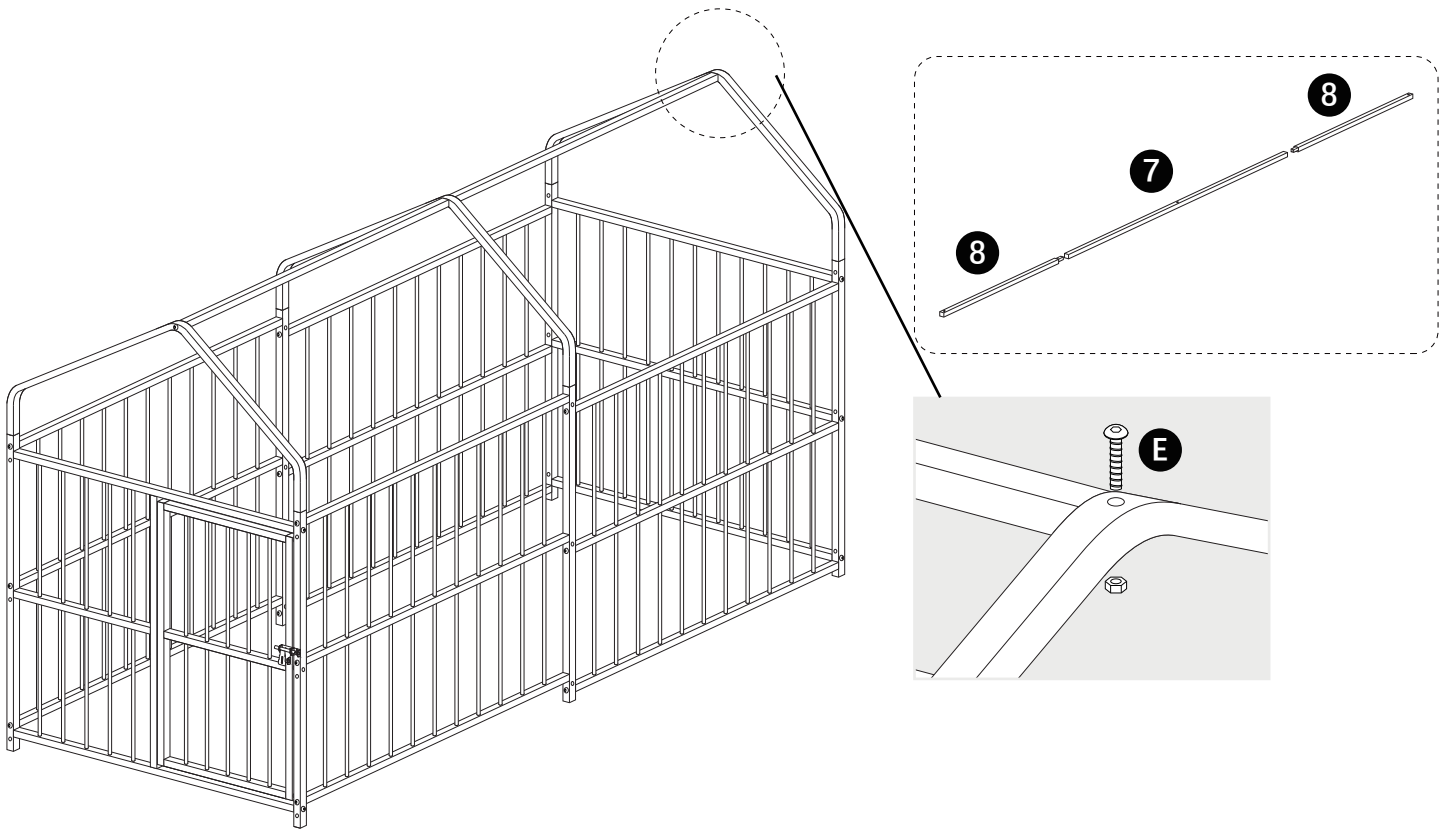

Step 8

Cover the roof fabric.

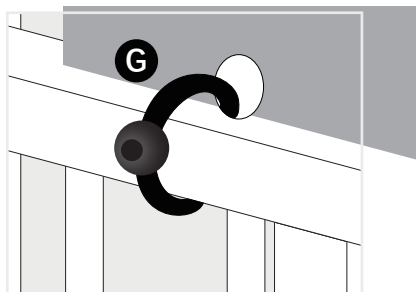

Fix the cover to the frame with G.

