

Metal Walk-in Chicken Coop Run

Instruction manual
For specification: 2m(L) x 3m(W) x 2m(H)

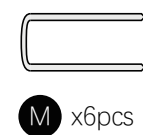

Please read this manual carefully before assembly

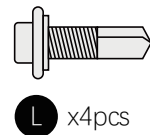
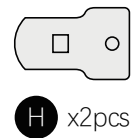
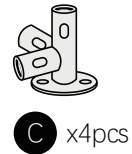
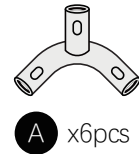
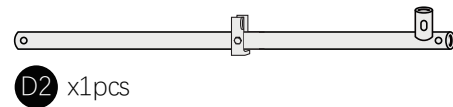
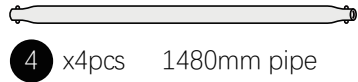
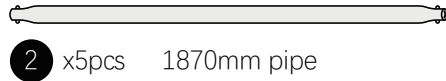
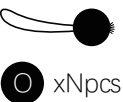
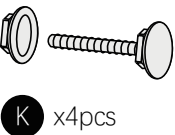
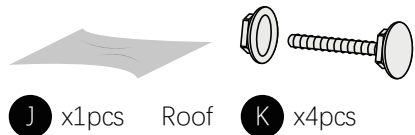
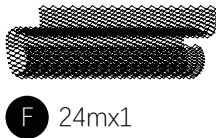
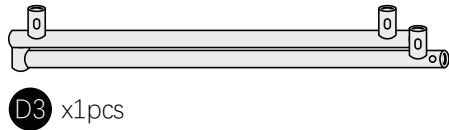
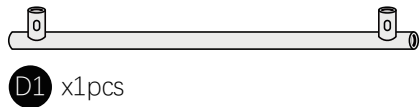
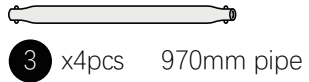
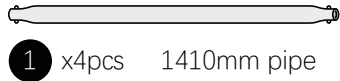

Step 1

Assemble the bottom frame as the below drawing.

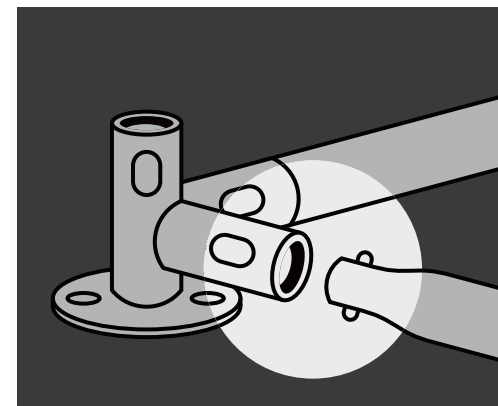
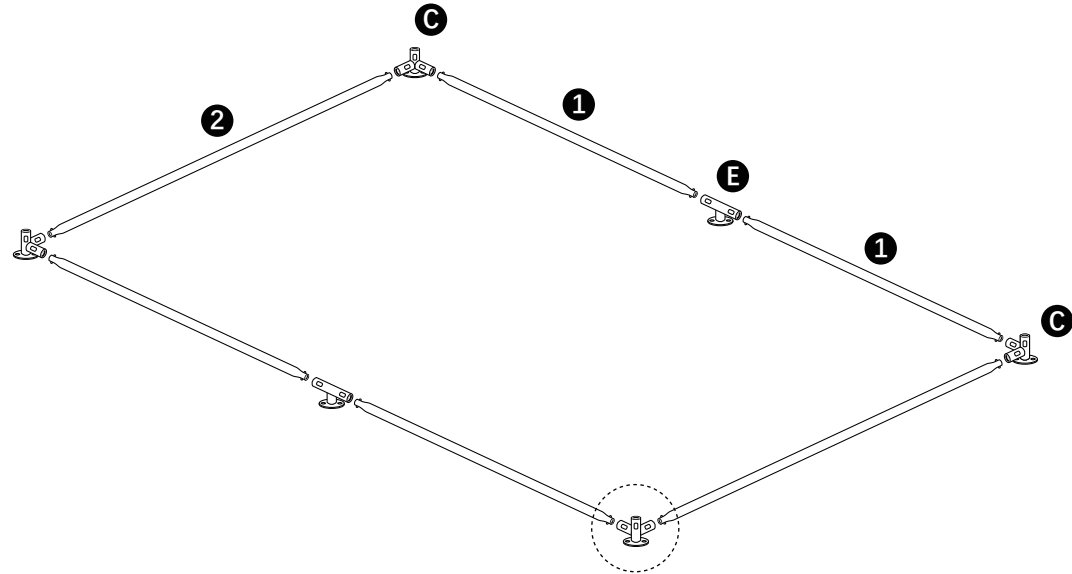

Step 2

Gather pipe "3"×4pcs, insert the pipes into the connectors "C" as the below drawing.

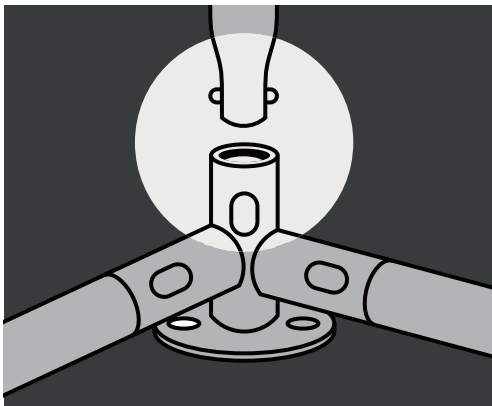
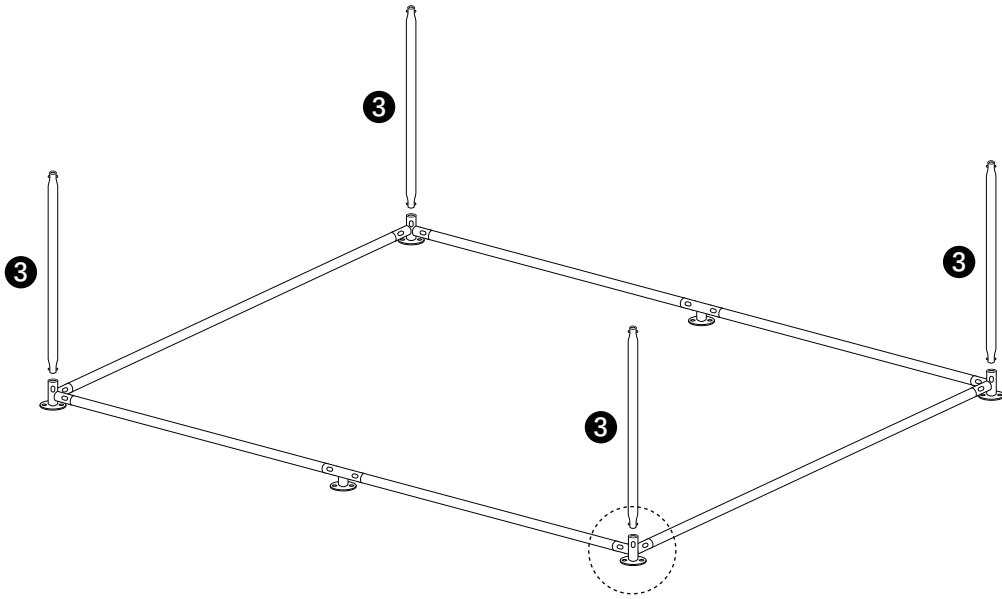

Step 3

Gather connector "A"×4pcs, and pipe "2"×2pcs, assemble as the below drawing.

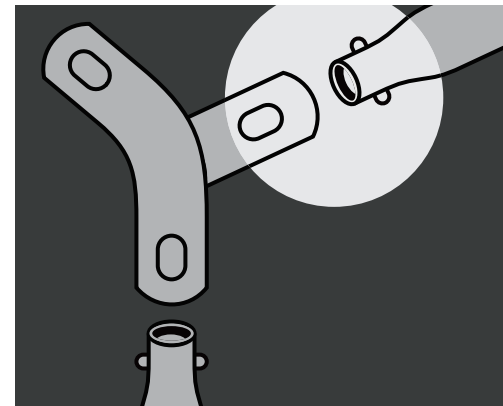
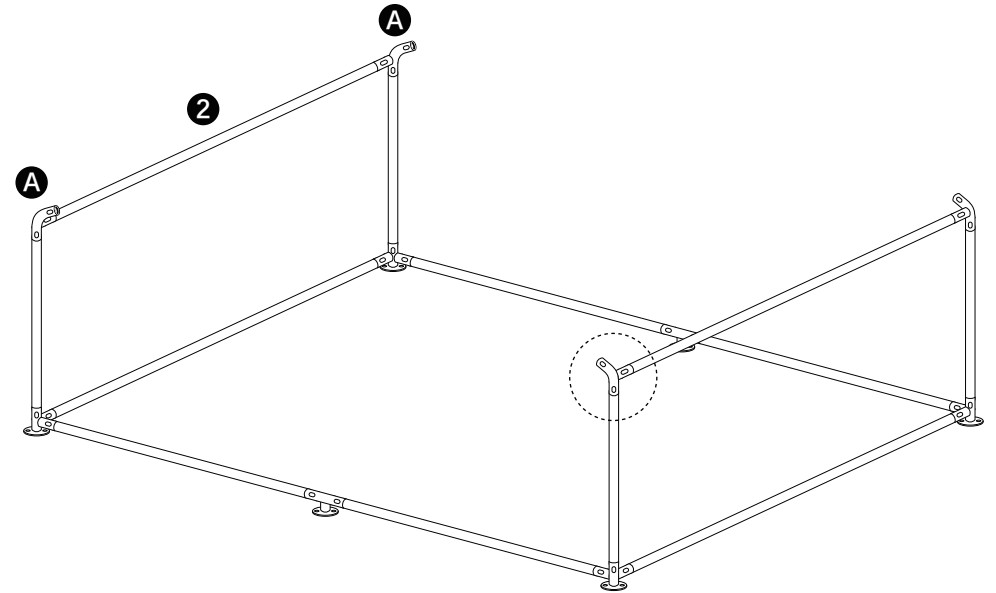

Step 4

Gather connector "A"×2pcs. Pipe "4"×4pcs and "2"×1pc
Assemble the top frame as the drawing.

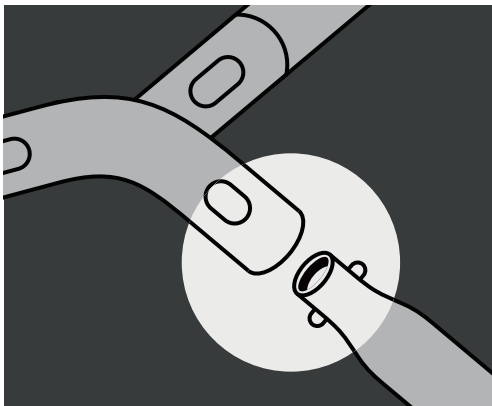
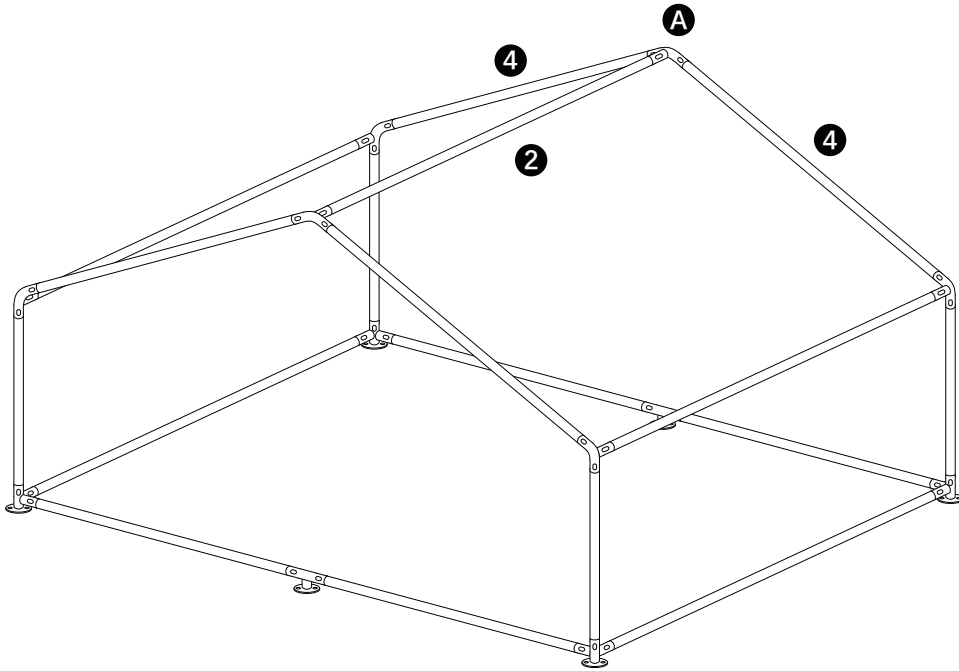

Step 5

Assemble the door with 1 pcs of "D1", 1pc of "D2", 1 pcs of "D3",
2 pcs of "5" and 1 pcs of "6".

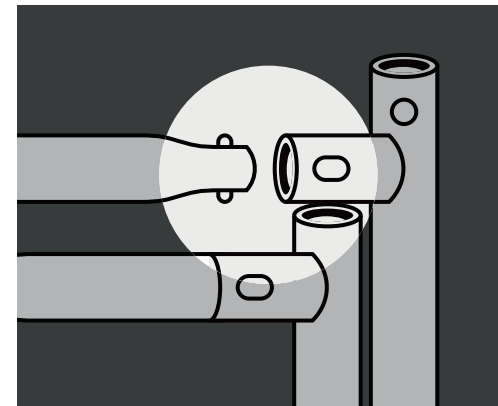
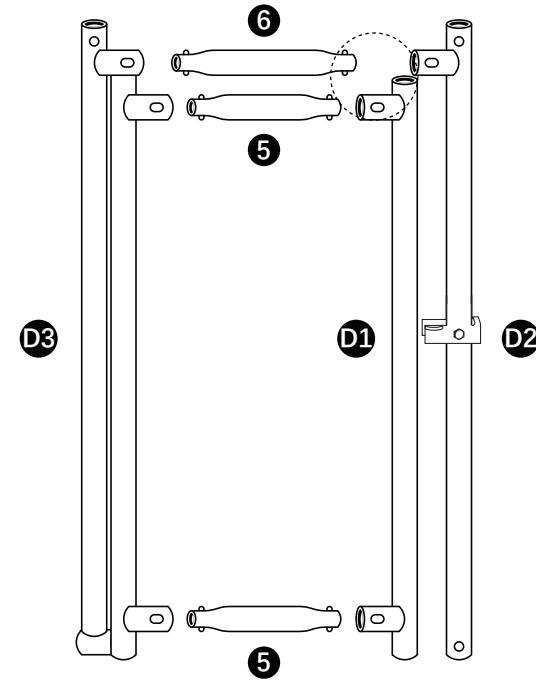

Step 6

Install the door to the chicken frame with "H"x2 pcs, "I"x2 pcs and screws.

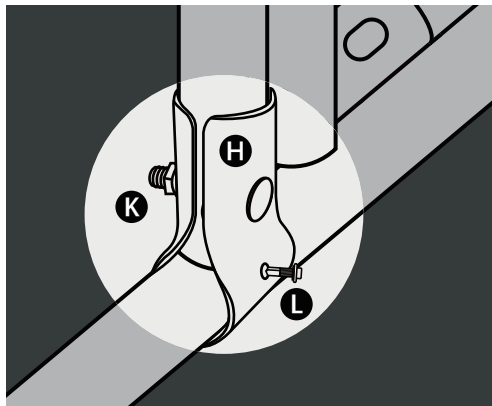
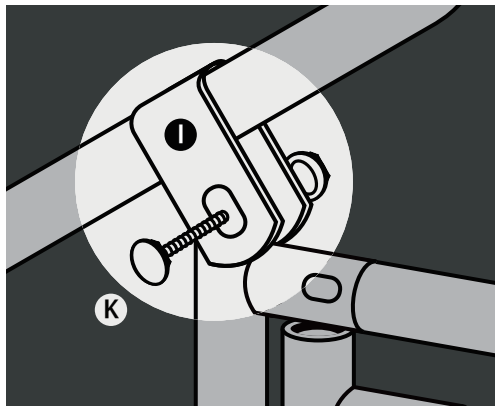
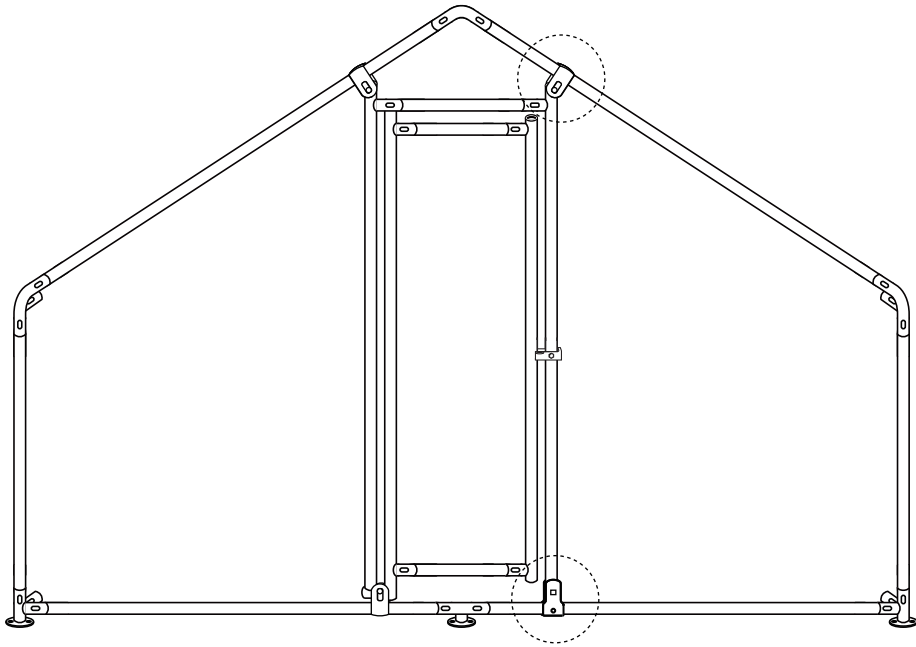

Step 7

Step 1: NO PRE-CUT! Cover around the house, then cut off finally. And tie it to the pipes with strap "N".

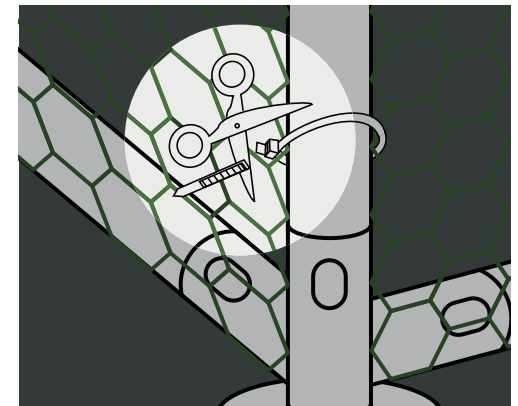
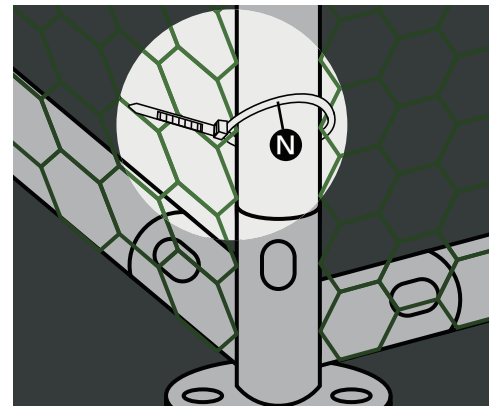
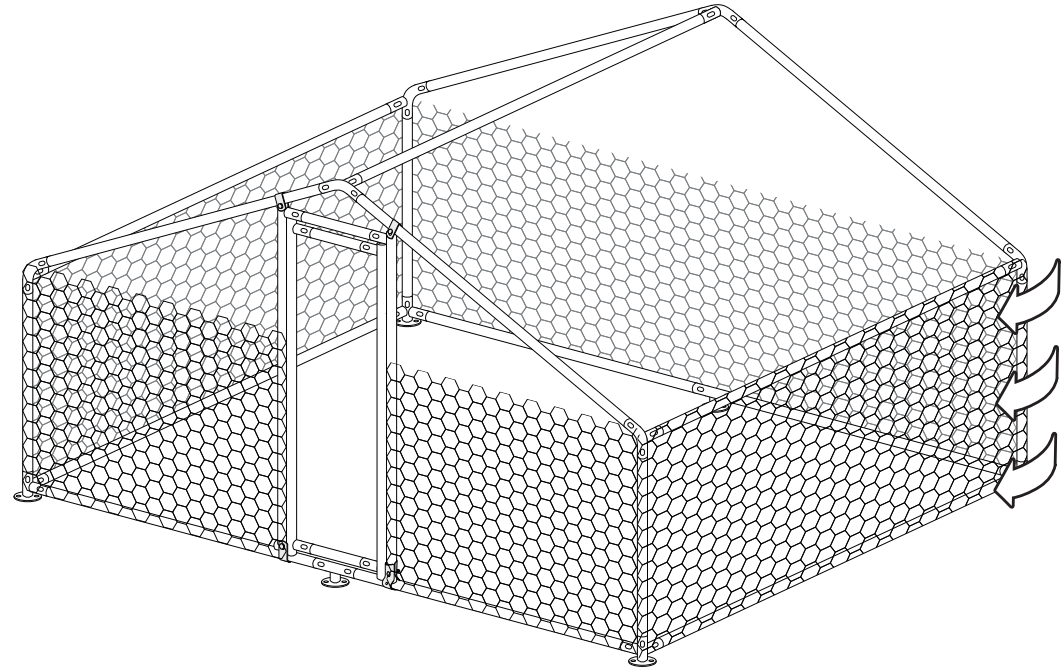

Step 8

NO PRE-CUT! Cover the top, finally cut off. And tie it to the pipes with strap "N".

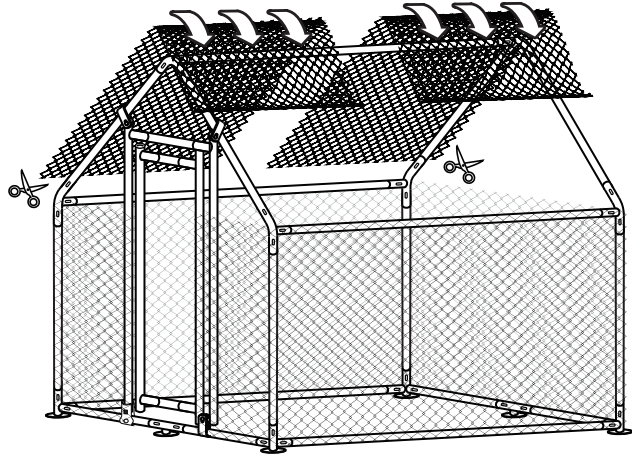

Step 9

Measure the Δ parts of front and back sides, Pre-cut the wire mesh for covering . And tie it to the pipes with strap "N".

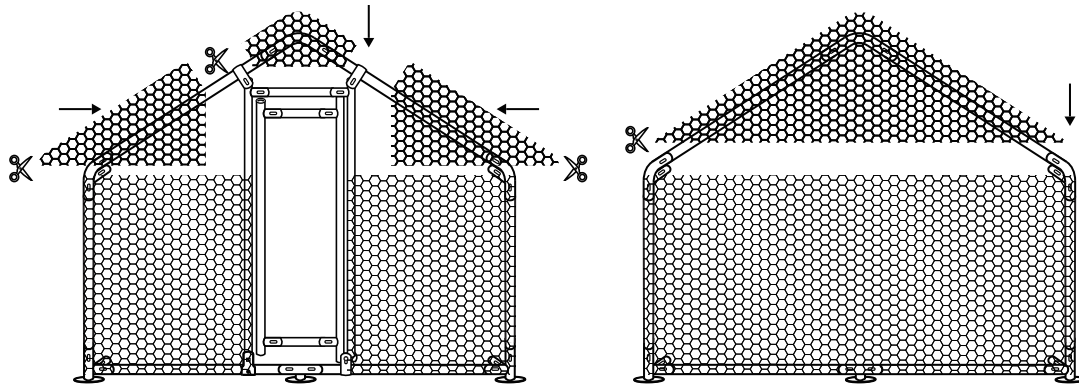

(Front)

(Back)

Step 10

Measure the door size, Pre-cut the wire mesh for covering . And tie it to the pipes with strap "N".

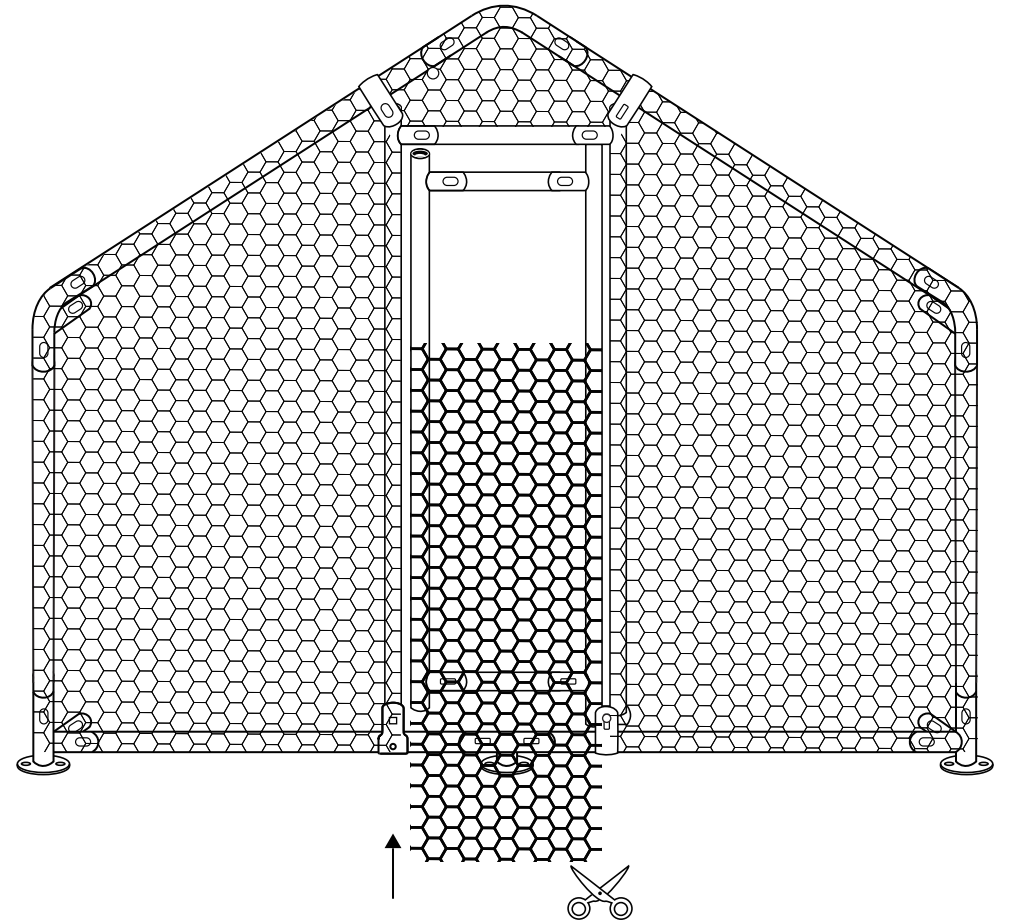

Step 11

Put the waterproof cover "J" on the frame, tighten it on the frame with "O".

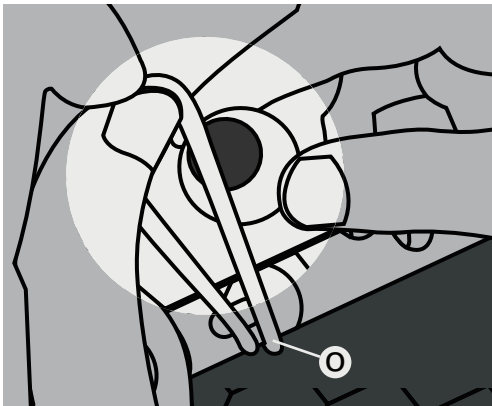
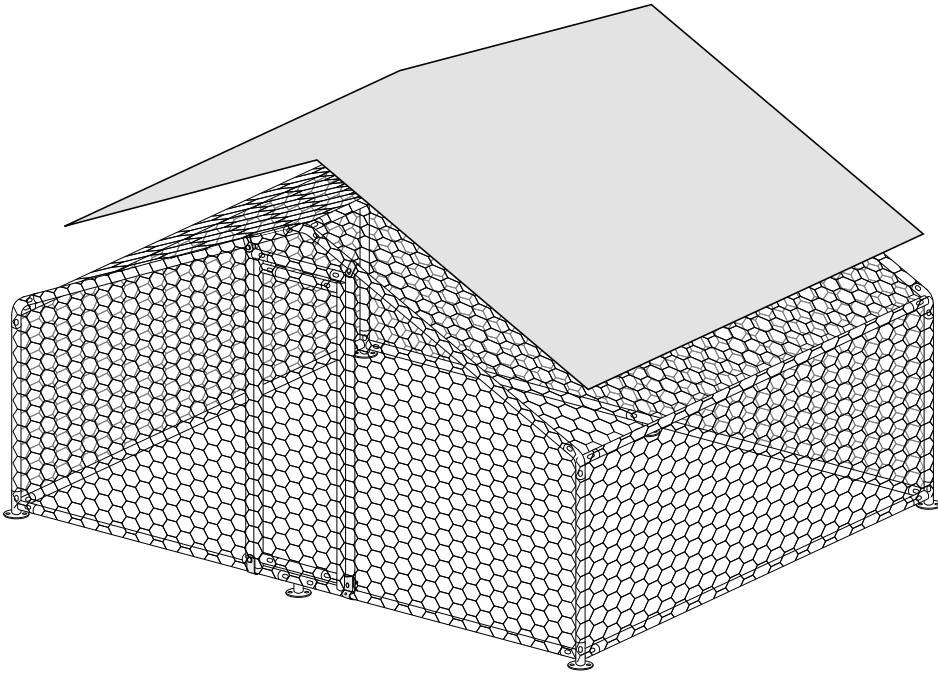

Step 12

Put the ground anchor "M" into ground to make the cage more stable and durable.

